

©2020 Hangzhou Hikvision Digital Technology Co., Ltd. All rights reserved.

About this Manual

The Manual includes instructions for using and managing the Product. Pictures, charts, images and all other information hereinafter are for description and explanation only. The information contained in the Manual is subject to change, without notice, due to firmware updates or other reasons. Please find the latest version of this Manual at the Hikvision website (<https://www.hikvision.com/>).

Please use this Manual with the guidance and assistance of professionals trained in supporting the Product.

HIKVISION and other Hikvision's trademarks and logos are the properties of Hikvision in various jurisdictions. Other trademarks and logos mentioned are the properties of their respective owners.

Disclaimer

TO THE MAXIMUM EXTENT PERMITTED BY APPLICABLE LAW, THIS MANUAL AND THE PRODUCT DESCRIBED, WITH ITS HARDWARE, SOFTWARE AND FIRMWARE, ARE PROVIDED "AS IS" AND "WITH ALL FAULTS AND ERRORS". HIKVISION MAKES NO WARRANTIES, EXPRESS OR IMPLIED, INCLUDING WITHOUT LIMITATION, MERCHANTABILITY, SATISFACTORY QUALITY, OR FITNESS FOR A PARTICULAR PURPOSE. THE USE OF THE PRODUCT BY YOU IS AT YOUR OWN RISK. IN NO EVENT WILL HIKVISION BE LIABLE TO YOU FOR ANY SPECIAL, CONSEQUENTIAL, INCIDENTAL, OR INDIRECT DAMAGES, INCLUDING, AMONG OTHERS, DAMAGES FOR LOSS OF BUSINESS PROFITS, BUSINESS INTERRUPTION, OR LOSS OF DATA, CORRUPTION OF SYSTEMS, OR LOSS OF DOCUMENTATION, WHETHER BASED ON BREACH OF CONTRACT, TORT (INCLUDING NEGLIGENCE), PRODUCT LIABILITY, OR OTHERWISE, IN CONNECTION WITH THE USE OF THE PRODUCT, EVEN IF HIKVISION HAS BEEN ADVISED OF THE POSSIBILITY OF SUCH DAMAGES OR LOSS.

YOU AGREE TO USE THIS PRODUCT IN COMPLIANCE WITH ALL APPLICABLE LAWS, AND YOU ARE SOLELY RESPONSIBLE FOR ENSURING THAT YOUR USE CONFORMS TO THE APPLICABLE LAW. ESPECIALLY, YOU ARE RESPONSIBLE, FOR USING THIS PRODUCT IN A MANNER THAT DOES NOT INFRINGE ON THE RIGHTS OF THIRD PARTIES, INCLUDING WITHOUT LIMITATION, RIGHTS OF PUBLICITY, INTELLECTUAL PROPERTY RIGHTS, OR DATA PROTECTION AND OTHER PRIVACY RIGHTS. YOU SHALL NOT USE THIS PRODUCT FOR ANY PROHIBITED END-USES, INCLUDING THE DEVELOPMENT OR PRODUCTION OF WEAPONS OF MASS DESTRUCTION, THE DEVELOPMENT OR PRODUCTION OF CHEMICAL OR BIOLOGICAL WEAPONS, ANY ACTIVITIES IN THE CONTEXT RELATED TO ANY NUCLEAR EXPLOSIVE OR UNSAFE NUCLEAR FUEL-CYCLE, OR IN SUPPORT OF HUMAN RIGHTS ABUSES.

IN THE EVENT OF ANY CONFLICTS BETWEEN THIS MANUAL AND THE APPLICABLE LAW, THE LATER PREVAILS.



This product and - if applicable - the supplied accessories too are marked with "CE" and comply therefore with the applicable harmonized European standards listed under the EMC Directive 2014/30/EU, RE Directive 2014/53/EU, the RoHS Directive 2011/65/EU.



replacement of a battery with an incorrect type that can defeat a safeguard (for example, in the case of some lithium battery types);
- disposal of a battery into fire or a hot oven, or mechanically crushing or cutting of a battery, that can result in an explosion;
- leaving a battery in an extremely high temperature surrounding environment that can result in an explosion or the leakage of flammable liquid or gas; and
- a battery subjected to extremely low air pressure that may result in an explosion or the leakage of flammable liquid or gas



2012/19/EU (WEEE directive): Products marked with this symbol cannot be disposed of as unsorted municipal waste in the European Union. For proper recycling, return this product to your local supplier upon the purchase of equivalent new equipment, or dispose of it at designated collection points. For more information see: www.recyclethis.info



2006/66/EC (battery directive): This product contains a battery that cannot be disposed of as unsorted municipal waste in the European Union. See the product documentation for specific battery information. The battery is marked with this symbol, which may include lettering to indicate cadmium (Cd), lead (Pb), or mercury (Hg). For proper recycling, return the battery to your supplier or to a designated collection point. For more information see: www.recyclethis.info

1 Introduction

The sensor can detect the door or window opening. When the door or window is open, an alarm will be triggered and it will be sent to the alarm center or mobile client via security control panel.

Door Magnetic Sensor Alarm: When the distance between the sensor and the magnetic stick is longer than 3 cm, an alarm will be triggered. The indicator will flash once.

Tamper Alarm: When removing the sensor, an alarm will be triggered.

2 Appearance

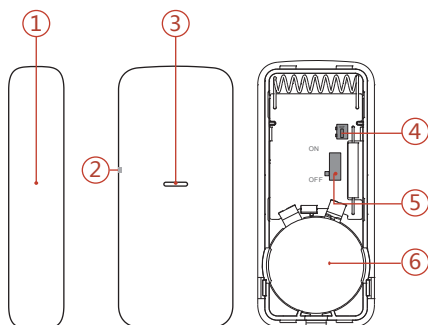

CAUTION

RISK OF EXPLOSION IF BATTERY IS REPLACED BY AN INCORRECT TYPE.
REPLACEMENT OF A BATTERY WITH AN INCORRECT TYPE THAT CAN DEFEAT A SAFEGUARD.

CAUTION

CHEMICAL BURNING DANGER
DO NOT SWALLOW THE BATTERY
KEEP NEW AND USED BATTERIES AWAY FROM THE CHILDREN.

CAUTION ⑥

DISPOSE OF USED BATTERIES ACCORDING TO THE INSTRUCTIONS AND LOCAL REGULATION.

IF YOU THINK BATTERIES MIGHT HAVE BEEN SWALLOWED OR PLACED INSIDE ANY PART OF THE BODY, SEEK IMMEDIATE MEDICAL ATTENTION.

① **Magnetic Stick**

② **Positioning Line**

③ **Indicator**

Alarm Detection: Red LED flashes.

Detector Formatted: Red LED flashes 3 times.

④ **TAMPER Button**

- Tampering Alarm: If the detector is disassembled, an alarm will be triggered.
- Formatting: Restore the device to default settings.

⑤ **Power Switch**

⑥ **Battery**

3 Power On

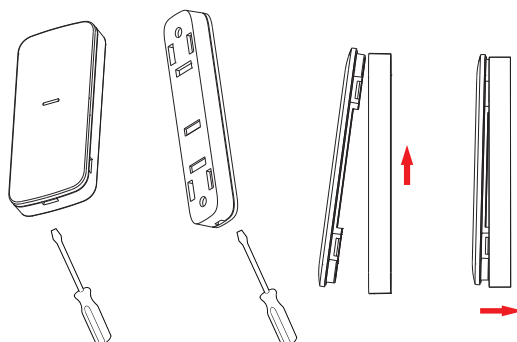

CAUTION

IF THE BATTERY COMPARTMENT DOES NOT CLOSE SECURELY, STOP USING THE PRODUCT AND KEEP IT AWAY FROM CHILDREN.

Dig the groove to disassemble the device. Remove the front and rear panel. Turn the power switch to ON to power on the device.

Note: Do not disassemble the device with sharps.

4 Enrollment

1. Log in to the APP Store, download and install App.
2. Power on the security control panel.
3. Log in the APP and tap the icon "+". Scan the QR code or input the control panel serial No. to add the control panel.

1 Enroll the Peripheral Locally

1. In the APP, tap the "Enrollment Mode" button on the control panel page to make the control panel enter the enrollment status.
2. Power on the peripheral, and it will be automatically enrolled to the control panel.

2 Enroll the Peripheral with QR and serial No.

1. In the APP, tap the icon "+" and scan the QR code or serial No. on the peripheral.
2. Power on the peripheral, and it will be automatically enrolled to the control panel.

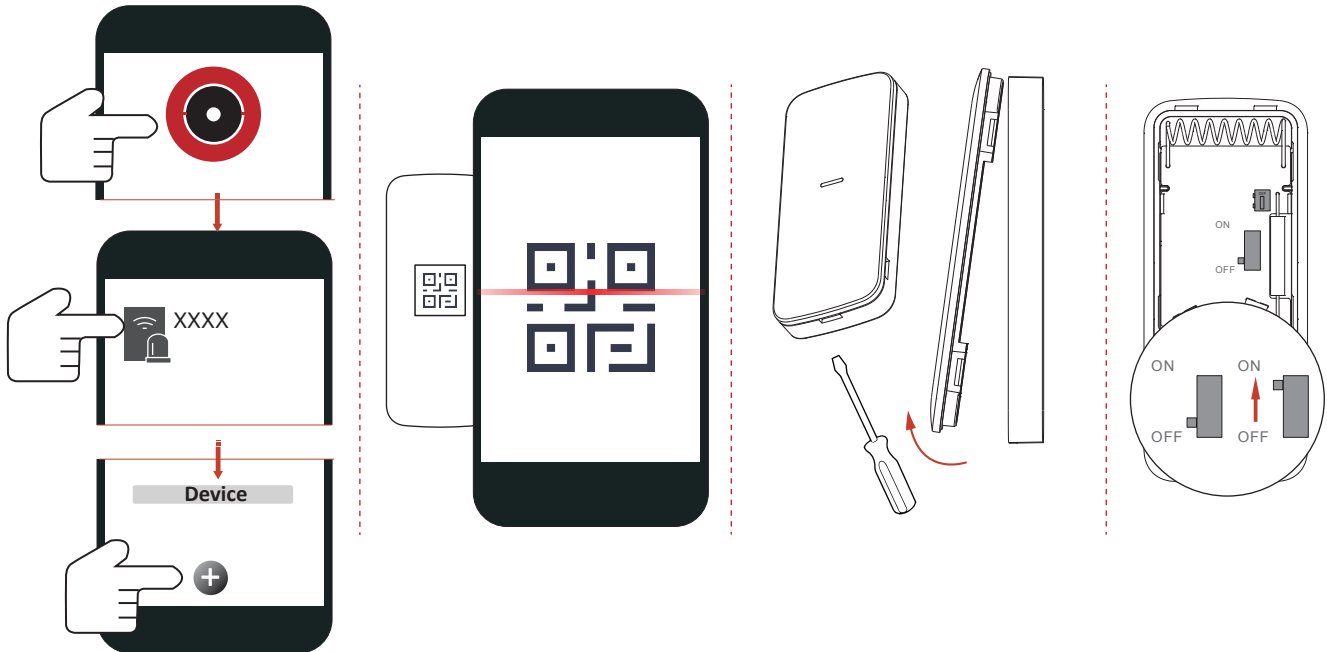

5 Test

The contact starts test automatically after being enrolled to the AX PRO. The LED turn red.

Separate the contact, and make a gap between the sensor and stick. while the LED turns green, the alarm is triggered by this gap . Adjust the installation position of the contact to get a satisfied alarm gap.

The alarm will be triggered while the gap between the sensor and magnetic stick is bigger than that shows in the table. The LED keeps blue for 2 s.

Magnet Detection Performance Table

Axes of Operation	Event	On non-ferromagnetic material surface	On ferromagnetic material surface
X+	Break	84	21
	Make	78	20
X-	Break	65	9
	Make	61	8
Y	Break	50	10
	Make	36	8
Z+	Break	52	11
	Make	47	9
Z-	Break	52	12
	Make	48	9

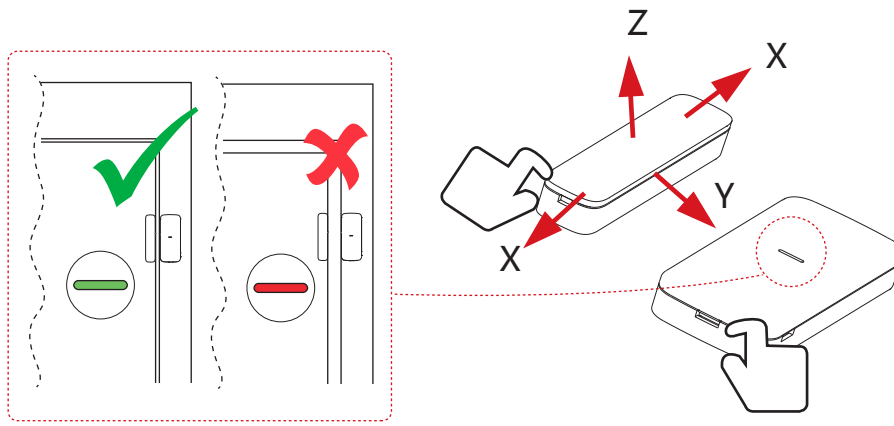

6 Installation

1. Check Signal Strength

Enter the signal checking mode by operating on the control panel. Trigger the detector.

- Solid Green for 3 s - Strong Signal
- Solid Orange for 3 s - Medium Signal
- Solid Red for 3 s - Weak Signal
- Red light flashes for 3S - Lost Signal

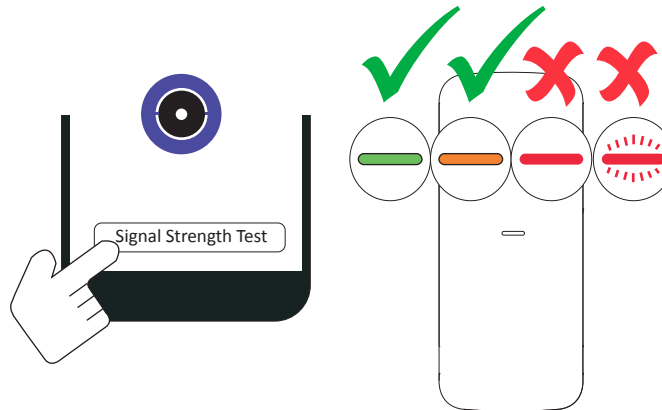

2. Install the Detector

a. Dig the groove to disassemble the device.

Method 1: Secure the rear panel to the wall with two screws.

Method 2: Paste rear panel on the wall with the sponge tape.

Note: To make the TAMPER work properly, the thickness of the sponge tape should be no more than 1mm.

Installing with sponge tape is non EN compliant.

b. Close the front and the rear panel.

Note: You should install the sensor and the magnetic stick at the door or window's edge. Make sure they are aligned with the door or window's edge.

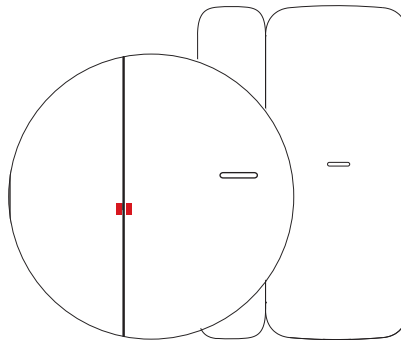

Align the Positioning Line

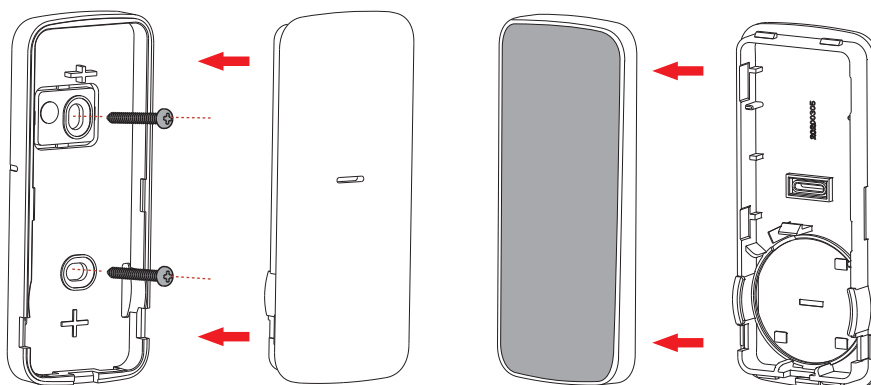

Method 1.

3

Method 2.

7 Formatting

1. Remove the battery.
2. Hold the TAMPER button and power the detector on at the same time.
The red LED flashes 3 time when the formatting is completed.

8 Set Up with App

You can view the device status including temperature, signal intensity, battery level, lid, magnetic contact, etc., on the device page.
Tap the  button to enter the settings page.

Disallowed field adjustable settings: None

Function	Description
Zone Type	Select the zone type of the detector.
Stay Arm Bypass	Slide to green to bypass the zone from stay arming.
Chime	Slide to green to enable the chime.
Enable Silent Zone	Slide to green to make the zone keep silent while alarm is triggered.
Double Knock	Slide to green to make the zone alarm with double knock.
Cross Zone	If the alarm triggered in both of the linked zones within the set time, two alarm messages will be reported.
Link Camera	Link with a camera for intruder verification.
LED	Turn On/Off the LED.
Polling Rate	Set the interval of heartbeat.
Signal Strength Test	Enter the test mode, and view the LED indication.
Detection Zone Test	Enter the test mode, separate the contact, and start the test with Magnet Detection Performance Table.
Zone Bypass	By pass the zone.

9 Operation Caution and Device Maintenance

- All the electronic operation should be strictly compliance with the electrical safety regulations, fire prevention regulations and other related regulations in your local region.
 - Do not drop the device or subject it to physical shock, and do not expose it to high electromagnetism radiation. Avoid the equipment installation on vibrations surface or places subject to shock (ignorance can cause equipment damage).
 - Please make sure that the power has been disconnected before you wire, install or dismantle the device.
 - If smoke, odors or noise rise from the device, turn off the power at once and unplug the power cable, and then please contact the service center.
 - Do not drop the device or subject it to physical shock, and do not expose it to high electromagnetism radiation. Avoid the equipment installation on vibrations surface or places subject to shock (ignorance can cause equipment damage).
 - Do not place the device in extremely hot (refer to the specification of the device for the detailed operation temperature), cold, dusty or damp locations, and do not expose it to high electromagnetic radiation.
 - The device for indoor use shall be kept from rain and moisture.
- Exposing the equipment to direct sun light, low ventilation or heat source such as heater or radiator is forbidden (ignorance can cause fire danger).
- Do not aim the device at the sun or extra bright places. A blooming or smear may occur otherwise (which is not a malfunction however), and affecting the endurance of sensor at the same time.
 - Improper use or replacement of the battery may result in hazard of explosion. Replace with the same or equivalent type only. Dispose of used batteries according to the instructions provided by the battery manufacturer.
 - Do not expose the device to the corrosive gas. Otherwise the equipment damage may occur.
 - Do not expose the device to the explosive situation.

	Model	DS-PDMCS-EG2-WB/WE
Detection	Detection Method	Opening Contact
Performance	Detection Gap	52mm Max
Feature	Digital Processing	Support
	Tamper Protection	Front,Rear
	Environment Temperature Indicator	Support
	Signal Strength Indicator	Support
Interface	Power Switch	Power Up Enrolling
	LED Indicator	Blue (Alarm)
Transmission	Transmission Technology	Tri-X Wireless
	Transmission Method	Two-Way RF Wireless
	Transmission Frequency	433/868MHz
	Transmission Security	AES-128 Encryption
	Transmission Range(Free Space)	1Km(433MHz)/1.2Km(868MHz)
	Frequency Hopping	Support
	Enrolling Method	Power up,Remote ID,QR Code
Electrical Characteristics	Power Supply	Battery Powered
	Battery Type	CR2450 x 1 (included), 3V/620mA
	Typical Voltage	3V
	Consumption	Max. current: 40 mA Quiescent current: 24μA
	Low Battery Level	2.68 V
	Standard Battery Life	3 Years
General	Operation Temperature	-10 °C to 55 °C (14 °F to 131 °F)
	Storage Temperature	-20 °C to 60 °C (-4 °F to 140 °F)
	Operation Humidity	10% to 90%
	Dimension(WxHxD)	29mm × 69mm × 10mm 14mm × 69mm × 10mm
	Weight	38g
	Application Scenario	Indoor