

Z14 USER MANUAL



CONTENTS

1	QUICK START GUIDE	6
1.1	CHANGING THE PROGRAMMING OPTIONS	6
1.1.1	RELAY FUNCTIONS	10
1.1.2	INPUT FUNCTIONS	12
1.2	JUMPERS	14
1.3	QUICK TEST OF CONFIGURED UNIT.	14
1.4	CONNECTING YOUR Z14 TO THE FENCE	16
1.5	MOST FREQUENTLY USED LCD KEYPAD COMMANDS	17
2	INTRODUCTION	18
3	FEATURES AND BENEFITS	20
3.1	MORE FEATURES	21
3.2	Z14R ADDITIONAL FEATURES	21
4	DESCRIPTION	22
4.1	JVA Z14 - EXTERIOR	22
4.2	FRONT PANEL STATUS LIGHTS.	23
4.3	FRONT PANEL LCD DISPLAY	23
4.4	INPUTS AND OUTPUTS	23
4.5	Z-SERIES MODELS.	24
4.6	Z-SERIES KEYPAD (OPTIONAL)	24
4.7	INTERNAL BEEPER/KEYPAD BEEPER	24
4.8	PROGRAMMABLE OPTIONS	25
4.9	ARM INPUT AND KEY SWITCH	25
4.10	GATE INPUT	25
4.11	LOW POWER MODE	25
4.12	AGRICULTURAL MODE	25
4.13	GROUP SIMULTANEOUS PULSE FEATURE	26
4.14	REMOTE CONTROL UNIT (OPTIONAL)	26
4.15	CABLING	26
4.16	LIGHTNING PROTECTION	26
4.17	EARTH LOOP MONITORING	27
4.18	NOISE AND INTERFERENCE	27
4.19	PC CONTROL	27

5	INSTALLATION	28
5.1	INSTALLATION STEPS	28
5.2	INTERIOR CONFIGURATION	29
6	CONTROL	32
6.1	ARMING THE FENCE USING THE KEYPAD.	32
6.2	ACTIVATING LOW POWER MODE	32
6.3	WHEN AN ALARM OCCURS	33
6.4	TO SILENCE THE ALARM	33
6.5	CHANGING THE USER PIN	33
7	TECHNICAL INFORMATION.	34
7.1	POWER OPTIONS	35
7.2	STANDBY BATTERY	35
7.3	STATUS CODES	36
7.4	JUMPERS	36
7.5	CONFIGURING BI-POLAR MODE	38
7.6	TAMPER CIRCUIT (Z14R ONLY)	38
8	PROGRAMMING OPTIONS	40
8.1	PROGRAMMING MODE	40
8.2	TO EXIT PROGRAMMING MODE.	40
8.3	CHANGING THE INSTALLER PIN	40
8.4	CHANGING AN OPTION	40
8.5	PROGRAMMING OPTIONS IN DETAIL.	41
8.5.1	OUTPUT POWER LEVEL (OPTION 1).	41
8.5.2	LOW POWER MODE OUTPUT VOLTAGE (OPTION 2)	41
8.5.3	FENCE RETURN ALARM VOLTAGE (OPTION 3)	42
8.5.4	FENCE RETURN ALARM VOLTAGE FOR LOW POWER MODE (OPTION 5)	42
8.5.5	MISSED PULSE COUNT (OPTION 6)	42
8.5.6	BATTERY ALARM VOLTAGE (OPTION 7)	43
8.5.7	SIREN ON TIME (OPTION 8).	43
8.5.8	SIREN OFF TIME (OPTION 9)	44
8.5.9	SIREN CYCLES (OPTION 10)	44
8.5.10	GATE ENTRY/EXIT DELAY (OPTION 13)	45
8.5.11	CHIME MODE (OPTION 14)	46

8.5.12	FENCE MODE	46
8.5.13	COMBINED OPTIONS (OPTION 16)	46
8.5.14	ANTI-BRIDGING THRESHOLD (OPTION 17)	47
8.5.15	COMBINED OPTIONS 2 (OPTION 18)	48
8.5.16	AUTO RE-ARM TIME (OPTION 20)	49
8.5.17	RELAY PROGRAMMING	50
8.5.18	RELAY FUNCTIONS.	51
8.5.19	GROUP MODE (OPTION 26).	52
8.5.20	INPUT FUNCTION AND TRIGGER	53
9	SPECIFICATIONS	54
9.1	Z14R SPECIFICATION	54
9.2	Z14 SPECIFICATION	55
10	Z-SERIES KEYPADS	57
10.1	PTE0240 4-LINE KEYPAD	57
10.2	PTE0230 TOUCH KEYPAD	58
10.3	CONNECTING MULTIPLE KEYPADS	59
10.4	KEYPAD CONFIGURATION NOTES	59
10.5	CALIBRATING THE VOLTAGE DISPLAY	60
10.6	SUMMARY OF KEYPAD FUNCTIONS	62
11	REMOTE CONTROL UNIT	66
11.1	FEATURES	66
11.2	INSTALLATION.	67
11.3	OPERATION AND CONFIGURATION	67
12	STANDARD REQUIREMENTS FOR SECURITY ELECTRIC FENCES	68
12.1	DEFINITIONS	68
12.2	GENERAL REQUIREMENTS FOR ELECTRIC FENCES	68
12.3	PARTICULAR REQUIREMENTS FOR ELECTRIC ANIMAL FENCES IN AUSTRALIA	70
12.4	INSTALLATION OF ELECTRIC SECURITY FENCES	71
12.4.1	GENERAL	71
12.4.2	LOCATION OF ELECTRIC SECURITY FENCE	71
12.4.3	PROHIBITED ZONE FOR PULSED CONDUCTORS	72
12.4.4	SEPARATION BETWEEN ELECTRIC FENCE AND PHYSICAL	

	BARRIER	74
12.4.5	PROHIBITED MOUNTING	75
12.4.6	OPERATION OF ELECTRIC SECURITY FENCE	75
13	APPENDIX A: GROUP SIMULTANEOUS PULSE FEATURE	76
13.1	GROUP SIMULTANEOUS PULSE FEATURE	76
13.2	GROUP MODE PROGRAMMING (OPTION 26)	76
13.3	GROUP LINKING VIA THE KEYPAD “BUS”	77

1 QUICK START GUIDE

1.1 CHANGING THE PROGRAMMING OPTIONS

Default Installer PIN	012345
Default User PIN	1234

First you have to enter Programming mode.

Command	Key1	Key2	Key3	Key4	Key5	Key6	Key7	Key8	Key9
Enter Programming Mode			Installer Pin				*	0	#

When you have entered Programming mode you can begin to enter the following options to configure your Z14 or Z14R Security Energizer. Default Values are highlighted in grey.

Command	Key1	Key2	Keys 3 and 4		Key5
Change The Installer PIN 6 Digits	0	0	Enter the new 6 digit Installer PIN		#
High Power Mode Power Level	0	1	Enter the value in Hundreds of Volts Example: to set 8.2kV, use 82 for keys 3 and 4. Default is 85 (8.5kV)		#
Low Power Mode Power Level	0	2	Enter the value in Hundreds of Volts Example: to set 1.3kV, use 13 for keys 3 and 4. Default is 11 (1.1kV)		#

Command	Key1	Key2	Keys 3 and 4														Key5	
Return Fence Alarm Voltage For High Power Mode	0	3	Enter the value in Hundreds of Volts														#	
			Example: to set 3.8kV, use 38 for keys 3 and 4. Default is 40 (4.0kV)															
Return Fence Alarm Voltage For Low Power Mode	0	5	Enter the value in Hundreds of Volts														#	
			Example: to set 0.8V, use 08 for keys 3 and 4. Default is 05 (0.5kV)															
Bad/Missed Pulse Count Before Alarm Triggers	0	6	Enter the number of Missed Pulses														#	
			Example: to set 14 counts, use 14 for keys 3 and 4. Default is 03															
Battery Alarm Voltage (olts). Alarm Value Shown, Reduced Power is 1V less	0	7	00	01	02	03	04	05	06	07	08	09						#
			9.0	9.5	10.0	10.5	11.0	11.5	12.0	12.5	13.0	13.5						
Siren On Time (S=Seconds, M=Minutes)	0	8	00	01	02	03	04	05	06	07	08	09						#
			10S	30S	1M	2M	3M	4M	5M	20M	45M	130M						
Siren Off Time (S=Seconds, M=Minutes)	0	9	00	01	02	03	04	05	06	07	08	09						#
			10S	1M	2M	5M	10M	20M	30M	40M	50M	60M						
Siren Cycles	1	0	00	01	02	03	04	05	06	07	08	09						#
			0	1	2	3	4	5	6	7	8	9						

Quick Start Guide

Command	Key1	Key2	Keys 3 and 4								Key5		
			00	01	02	03	04	05	06	07		08	09
Gate Entry/Exit Delay (S=Seconds, M=Minutes)	1	3	0S	30S	1M	2M	3M	4M	5M	6M	7M	8M	#
Chime Mode	1	4	00	00	01	01	02	02	03	03	04	04	#
Combined Options 1 (add up the options you want. e.g. for Max Power and Limit output: 2 + 4 = 6 Therefore enter 06 for keys 3 and 4	1	6	+2	None	Door Chime	Siren	Siren	Fence Alarm	+16	+32	Gate Beeps Plus Siren	#	
			Maximum Power at all times	Limits output to 2.5J per Zone	Enables IR Tamper.	Stop Group ID on comms fail	Stop Energizer sending alarm memory						
Anti Bridging Threshold	1	7	Enter in the percentage difference required to trigger the Anti-Bridging alarm. e.g. if you require a 10% change in return voltage to trigger the alarm, enter 10 for keys 3 and 4. Default is 00 (Disabled)										#

Command	Key1	Key2	Keys 3 and 4								Key5		
			+1	+2	+4	+8	+16	+32	+64	+128			
Combined Options 2 (like Combined Options 1)	1	8	+1	+2	+4	+8	+16	+32	+64	+128	#		
			Siren Chirp on Arm	Enable Entry Exit Gate	4800 Baud	9600 Baud	Low Power to Bite	Bite to Low Power					
Auto Re-arm Time	2	0	00	01	02	03	04	05	06	07	08	09	#
S=Seconds, M = Min- utes, D=Disabled			0S	30S	1M	2M	3M	4M	5M	6M	7M	D	
Relay 1	2	1	Options Explained under "1.1.1.1 Relay Functions" Default is 08										
Relay 2	2	2	Options Explained under "1.1.1.1 Relay Functions" Default is 09										
Relay 3 (Z14R only)	2	3	Options Explained under "1.1.1.1 Relay Functions" Default is 00										
Relay 4 (Z14R only)	2	4	Options Explained under "1.1.1.1 Relay Functions" Default is 02										
Relay 5 (Z14R only)	2	5	Options Explained under "1.1.1.1 Relay Functions" Default is 07										
Group Mode	2	6	00	01	02	etc						15	#
			No Group	Master	Group ID 1	Group ID 14							
Input 1	2	7	Options Explained under "" Default is (Momentary Arm)										
Input 2	2	8	Options Explained under "" Default is 06 (N/O Gate 1)										
Exit Programming Mode	*	#											

Quick Start Guide

1.1.1 Relay Functions

The table below is for use for the relay programming options mentioned in the table on the previous page.

Keys 3 and 4	Function	Description
00	Fence	Triggers when Zone 1 is Armed and Return Voltage is below the Threshold Voltage In Bipolar - Triggers when the positive output is below the Threshold Voltage
01	Fence or Off	Triggers when Zone 1 is Disarmed or Return Voltage is below the Threshold Voltage
02	Armed	Zone 1 is Armed
03	Fence 2	Bipolar only - Triggers when the negative output is below the Threshold Voltage
06	Fence Bi-Polar	Triggers when energizer is Armed and the fence Return Voltage on either Bi-Polar return line has fallen below the Threshold Voltage
07	General	Triggers on AC Fail, Tamper, Low Battery/Bad Battery, Gate Alarm or Internal error. Latched (internal errors only)
08	Siren	Triggers on Fence Alarm, Gate or Tamper. Will time out after the Siren Time Out time. Latched
09	Strobe	Triggers on Fence alarm, Gate or Tamper. Only turns off on Energizer Disarm. Latched
10	AC Fail	Triggers on AC Fail
11	Low/Bad Battery	Triggers on Low or Bad Battery
12	Tamper	Triggers when the case has been opened and J3 has been fitted (Z14R only)
14	Gate	Triggers on Gate Alarm
15	Siren Caused by Gate	behaves like siren, only for Gate Alarms

Keys 3 and 4	Function	Description
16	Armed - Low Power Mode	Triggers when Armed in Low Power mode
17	Group Armed	Triggers when group is Armed. Only configurable on group master.
18	Group general	Triggers on group general Alarm. Only configurable on group master.
20	Host Control	This Relay is completely controlled from a Host system such as Perimeter Patrol or a Keypad. If the Host system is disconnected from the Energizer for more than 30 seconds, the Relay will automatically change to the Alarm State
21	Host Control - Not Fail Safe	This Relay is completely controlled from a Host system such as Perimeter Patrol or a Keypad. If the Host system is disconnected then the Relay will maintain its current state until the Host re-connects and requests the relay to change state.

Quick Start Guide

1.1.2 Input Functions

Key3	Input Trigger	Key4	Input Function
0	Normally Open (Active when Closed)	0	Arm when Active / Disarm otherwise
1	Normally Closed (Active when Open)	1	Arm when Active / Disarm otherwise
2	Momentary Toggle (Toggle between states)	2	N/A
3	NO Pulse Extend (Extend a short Close signal by 3 seconds)	3	Low Power when Active / High Power otherwise. Requires Energizer to be Armed
4	NC Pulse Extend (Extend a short Open signal by 3 seconds)	4	Low Power when Active / High Power otherwise. Requires Energizer to be Armed
		5	N/A
		6	Gate is Open when Active / Closed otherwise
		7	N/A
		8	Tamper Alarm triggered when Active
		9	Pass Through input signal to other device

1.2 JUMPERS

Jumpers quickly allow you to turn on and off different features, or reset the device to defaults. For more information on how to use the configuration jumpers and what each one does refer to “7.5 Jumpers” on page 37.

JUMPER	FUNCTION
J3 (Z14)	Inhibit AC fail error.
J3(Z14R)	Tamper disable.
J4	Factory default jumper Off to return programmable options to factory defaults on power up.
J5, J6 & J7	Supplies +12V to the Common terminal of Relay 3, 4, 5.

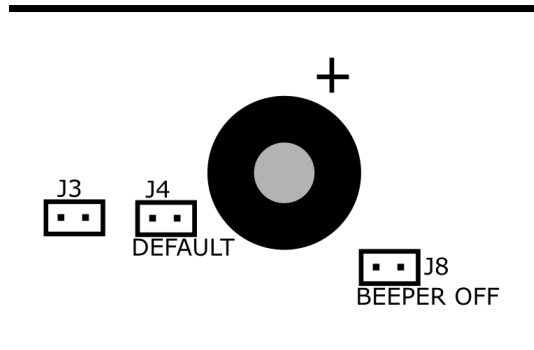

Jumpers located on the top right hand side of the board

1.3 QUICK TEST OF CONFIGURED UNIT

Now that the Z14 is configured to your fences requirements, it is a good idea to test the configuration before connecting the Z-Series energizer to a fence. The reason for this is that you could get spurious results if you test on the final fence and you will never be certain whether the issue lies with the fence, the Z-Series energizer, or the configuration of the unit itself.

To test your unit it is best to connect your Z14 with a test fence, this is done by connecting cables as shown in the picture below.

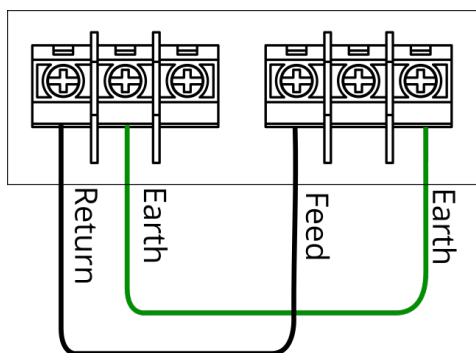

Power the Z14 and then Arm it. The unit should begin pulsing and not show any alarms. Disarm the Z14 and remove the fence cable as shown in the picture below.

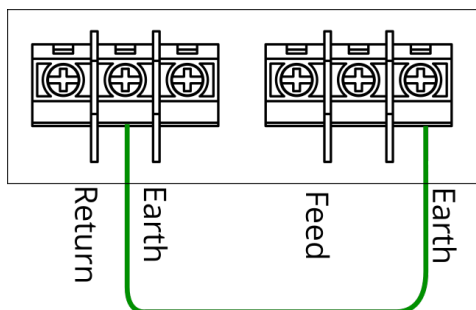

Arm the Z14 once again, after 3 pulses (unless you configured it otherwise) the unit should go into alarm as the fence will appear to be cut. Check that any sirens, strobes or relays correctly activate as you expect.

If your site consists of multiple Z-series test each energizer one at a time as shown in the above photographs. Following that each energizer should be assigned a unique group ID with only one Z-Series device as the master unit (For more information see “13 Appendix A: Group Simultaneous Pulse Feature” on page 76). After that each Z-Series device can be connected together via the keypad bus and tested using group Arm and Disarm commands, they should all pulse in unison when armed.



By disconnecting each Z-Series Energizer in turn from the keypad bus (shown in the above diagram) you can check to see how each Z-Series device behaves under comms fail conditions. This way, you can test to see that the relays have been configured correctly for comms fail. Once you are satisfied that each Z-Series device is configured correctly you can begin to wire them to the real fence.

1.4 CONNECTING YOUR Z14 TO THE FENCE

This is covered under “5.3 Examples of Fence (High Voltage) Wiring Diagrams” on page 30. In depth installation instructions begin on page 28. After the Z14 has been wired up you can begin to protect your perimeter.

1.5 MOST FREQUENTLY USED LCD KEYPAD COMMANDS

For a full list of all keypad commands please see “10.6 Summary Of Keypad Functions” on page 62.

Default Installer PIN	012345
Default User PIN	1234

First you need to connect the Z-Series LCD keypad to the Z-Series device. Once you have a keypad connected you can refer to the table below to control the Z-Series device.

Command	Key1	Key2	Key3	Key4	Key5	Key6	Key7	Key8	Key9
Arm/Disarm		User PIN			#				
Silence alarm	1	4	7	0	#				
Enter Programming Mode		Installer PIN							
Exit Programming Mode	*	#							
Arm All Zones		User PIN			*	1	0	#	
Arm Specific Zone (up to Zone 15)		User PIN			*	1	Zone Number		#
Disarm all Zones		User PIN			*	2	0	#	
Disarm Specific Zone (up to Zone 15)		User PIN			*	2	Zone Number		#
Clear alarm memory	*	1	#						

2 INTRODUCTION

Thank you for purchasing a JVA security electric fence energizer. The growing use of non-lethal electric security fences around the world is indicative of the confidence security professionals are placing in this form of perimeter security. The reason for this popularity is simple – monitored electric security fences are effective and they reduce false alarms when compared to other technologies.

DEMARICATION	The JVA electric fence around your property shows you mean business.
DEFLECTION	Intruders are deflected to softer targets.
DETERRENCE	The safe, powerful JVA shock is a strong deterrent to intruders.
DELAY	The barrier will help delay an intruder, giving you more time to react.
DETECTION	The JVA's voltage monitor warns you of any tampering with the fence.
DEPENDABLE	60 seconds a minute, 60 minutes an hour, 24 hours a day, 365 days a year, your JVA electric security fence is monitored by an alert, sober, electronic watchman.

Once every second the JVA Z14 energizer produces a very short-duration, safe, high-voltage pulse and sends it down the fence live wires. The JVA Z14 then monitors the voltage at the end of this live wire, checking that the voltage is being maintained along the entire fence line. In the event of a voltage drop caused by shorting, cutting or poor fence maintenance, the monitor will trigger an alarm, alerting you to the problem.

Designed and manufactured to meet the most stringent international safety standards, the JVA Z14 is in a class of its own when it comes to features and benefits at an affordable price.



Feature	Benefits
Australian designed and manufactured	High reliability and great service
Programmable Options	Customise the energizer to unique fence conditions
Wall-mountable, robust enclosure with easily detachable PCB chassis	Ease of installation and repair
Inbuilt LCD voltage display and status lights	See fence conditions at a glance
Internal 7Ah 12V rechargeable battery	Ensure continued operation of your security electric fence in the event of a mains power failure
Optional LCD Keypad	Ease of control and display of fence voltages
Optional PC and internet connections	Integration with security information management systems
Low Power mode	Detection together with reduced voltage for during the day
Switched +12V outputs for Siren and Strobe	Local audible and visual indication alerting user to breach of security
Earth monitor input	Ensures that all the wires on the fence are monitored continually
Enclosed fence terminals	Tamper resistant and prevents accidental contact with high voltage

3.1 MORE FEATURES

- Meets Safety and EMC standards (reports available on request)
- Powerful 4 joules peak output energy
- High and low Power mode
- Built in charger and space for a 12V 7.2aH backup battery
- Alarms on fence short or open circuit
- Control and programming via a Z-Series keypad
- Monitor via PC (using Perimeter Patrol software)
- Internal beeper
- AC fail, low battery and bad battery detection
- Large number of keypad programmable options
- Adjustable fence voltage level
- Can be configured as conventional or Bi-Polar
- Two 12V dc switch outputs (also referred to as relays)
- Two control Inputs configured as NO or NC contacts

3.2 Z14R ADDITIONAL FEATURES

- Three “Form C” relays with dry contacts or switched voltage output
- Relays may be assigned to any alarm function
- Infrared tamper beam disables the energizer if the lid is removed
- Approved for sale in Australia and New Zealand (Electrical Safety Approval)

4

DESCRIPTION

4.1

JVA Z14 - EXTERIOR



4.2 FRONT PANEL STATUS LIGHTS

Status Light	Description
POWER	On whenever the unit has power
ARMED	On when the unit is armed (pulsing), will flash when in Low Power mode
FENCE	Green when voltage on and OK, Red when there is a fence alarm
GATE	On when there is a gate alarm
STATUS/FAULT	The number of times the status/fault light flashes indicates any faults on the energizer. See the table in section "7.3 Status Codes" on page 36

4.3 FRONT PANEL LCD DISPLAY

The display on the JVA Z14 shows the voltage at the fence and return terminals. The left is the return and the right is the feed voltage. Arrows at the top of the display indicate that the energizer is in conventional mode. When configured for Bi-Polar operation the left hand side is the positive return voltage whilst the right hand side is the negative return voltage.

The LCD also shows the programming option and current setting when in programming mode. This allows the programming options settings to be checked easily.

4.4 INPUTS AND OUTPUTS

See "7 Technical Information" on page 34.

4.5 Z-SERIES MODELS

- Z11 Single zone, conventional 1.5 Joule.
- Z13 Single zone, conventional 2.8 Joule.
- Z14 Single zone, conventional or Bi-Polar 5 Joule.
- Z14R Z14 with relays and IR Tamper circuit, 4 Joule.
- Z14E Z14R for high value animals. When the Z14E detects a ground short it switches to low power mode until the short is removed. If an animal is caught in the fence, causing the short, it will be in less distress than with a conventional security energizer.
- Z18 Single zone, conventional or Bi-Polar 8 Joule, contains relays and IR Tamper circuit.
- Z28 Dual zone, conventional 8 Joule (4 Joules per zone).
- ZM1 Single zone start of fence monitor with Distant Fault Detection™
- ZM20 Twenty sector loop monitor.
- ZLM4 Four zone low voltage electric fence monitor.

4.6 Z-SERIES KEYPAD (OPTIONAL)

A Z-Series keypad allows for easy remote control of your JVA energizer. Arming and disarming, responding to alarms or just checking the fence voltage, the keypad makes this easy through a simple menu system or key sequences (shortcuts). Your security is protected by a user PIN.

A keypad also is required to change the programmable options, see “8 Programming Options” on page 40.

4.7 INTERNAL BEEPER/KEYPAD BEEPER

Depending on the chime setting, the internal beeper and keypad beeper will sound when there is a fence alarm, a gate alarm, a door chime or a general alarm.

4.8 PROGRAMMABLE OPTIONS

The Z14 has many programmable options. To alter these options, a Z-Series keypad must be used. The options are explained in “8.5 Programming Options in Detail” on page 41. Each parameter has a factory set default.

4.9 ARM INPUT AND KEY SWITCH

The JVA Z-Series energizer can be armed (to energise the fence) by closing a contact wired into the arm input. On some models a key switch is fitted to the right-hand side of the case for this purpose.

An external switch device, for example a remote receiver or access control keypad, can also be wired into the energizer to arm and disarm the unit.

4.10 GATE INPUT

An input can be configured for a Gate Function and wired to a gate switch to trigger an alarm when a gate is opened. Alternatively, it may be programmed to many other functions. For more information see “8.5.20 Input Function and Trigger” on page 53.

4.11 LOW POWER MODE

Z14 energizers can be switched into Low Power mode. Low Power mode may be used in situations where the fence is not required to be a deterrent but is still required to actively detect intrusion. In Low Power mode the fence live wires operate at a much lower voltage, typically 500V peak.

4.12 AGRICULTURAL MODE

The Z-Series Energizer can be armed in Agricultural Mode to provide a way test the fence without triggering any of the alarms. This mode should only be used to confirm that a new installation is operating correctly. The Energizer will remain in this mode until the Energizer is Disarmed.

The Fence Alarm LED will flash to indicate the return voltage is below the threshold, however it will not trigger the alarm.

4.13 GROUP SIMULTANEOUS PULSE FEATURE

In some installations it may be preferable to provide the ability to link multiple units into a group. When linked, the individual Z-Series devices become a group. As many as fifteen energizers can be grouped. Individual units in a group have simultaneous high voltage output pulses and act as if they are one energizer with multiple outputs. This is designed so that no possible combination of individual outputs can be dangerous. For more information see “13 Appendix A: Group Simultaneous Pulse Feature” on page 76

4.14 REMOTE CONTROL UNIT (OPTIONAL)

The Remote Control Unit provides the Z14 with the ability to arm or disarm the energizer via a compact key chain fob remote control. If using the remote control the siren can be used to acknowledge arming with 1 beep and disarm with 2 beeps, see programming option “8.5.11 Chime Mode (Option 14)” on page 46.

The remote controls have a range of up to 100 metres. They come fitted with a LR27A 12V battery that will provide up to 2 years service.

4.15 CABLING

High voltage cabling (fence feed and returns) should be run using suitably rated cable. Double insulated electric fence “underground” cable is suitable. High voltage cables must never be run within the same conduit as low voltage cables. A minimum distance of 30mm should be kept between high voltage and low voltages cables.

To maintain the IPx4 rating of the enclosure and to ensure moisture does not enter the enclosure via the cable entry area a silicon sealant (neutral cure) must be used to seal all the cable passages.

4.16 LIGHTNING PROTECTION

Although the Z14 contains internal lightning protection elements, external lightning protection elements such as additional external lightning protection kits are recommended to further reduce lightning damage and thus reduce repair costs. They are available from your local dealer.

4.17 EARTH LOOP MONITORING

The Z14 has two fence earth terminals. If the earth monitoring facility is not required, the Earth Out and Earth Return terminals must be joined with a wire bridge. Directions on how to wire for earth loop monitoring are in Section “5.3 Examples of Fence (High Voltage) Wiring Diagrams” on page 30.

4.18 NOISE AND INTERFERENCE

The Z14 contains a microprocessor. Extreme electrical noise can upset microprocessors. The most likely cause of such noise is the high voltage output from the unit itself. In the event of erratic behaviour, check that the high voltage wiring is firmly connected to the terminals and that no sparking is seen. The Z14 is designed to self-recover from interference. Powering off (both AC and battery) should not be necessary.

4.19 PC CONTROL

A standard Windows PC may be used to control and monitor a group of Z-Series devices. Ask your JVA distributor for a demonstration of Perimeter Patrol™ software. Z-Series devices can be connected to a PC using either a serial data adaptor, such as the PAE223 or TCP/IP using a PAE212.

5 **INSTALLATION**

JVA recommends installation by qualified technicians.

5.1 **INSTALLATION STEPS**

1. Read the entire manual first!
2. Design and build the fence. (Beyond the scope of this manual.) Ask your distributor for help if required.
3. Decide where the JVA Z14 is to be mounted. If on an external wall it should be housed within a waterproof equipment box and definitely not in direct sunlight.
4. Remove the JVA Z14 PCB chassis from the housing.
5. Mount the housing using 4 screws through the rear of the box.
6. Replace the PCB chassis.
7. If using a keypad, remove the rear housing of the keypad and fix it to the wall.
8. Wire the low voltage cables to the PCB terminals*.
9. Wire the high voltage cable to the PCB terminals*.
10. If earth monitoring is not going to be used on the fence, connect a bridge wire from earth out to earth return.
11. Ensure that the key switch is off.
12. Fit the battery leads to the battery.
13. Mount the 230 – 16V transformer and connect the 16V side to the Z14 16V input terminals. Do not connect a live or neutral to the earth terminal on the PCB.
14. Replace the front cover.
15. Turn AC power on.
16. Arm the unit.
17. Check to ensure that a short anywhere on the fence triggers the alarm.

Ensure that the user understands how to change the User PIN and is in possession of this Installer/User Manual and the installer's contact details.

* NOTE: Keep high voltage and low voltage cables at least 30mm apart. Do not run high and low voltage cables in the same conduit.

5.2 INTERIOR CONFIGURATION

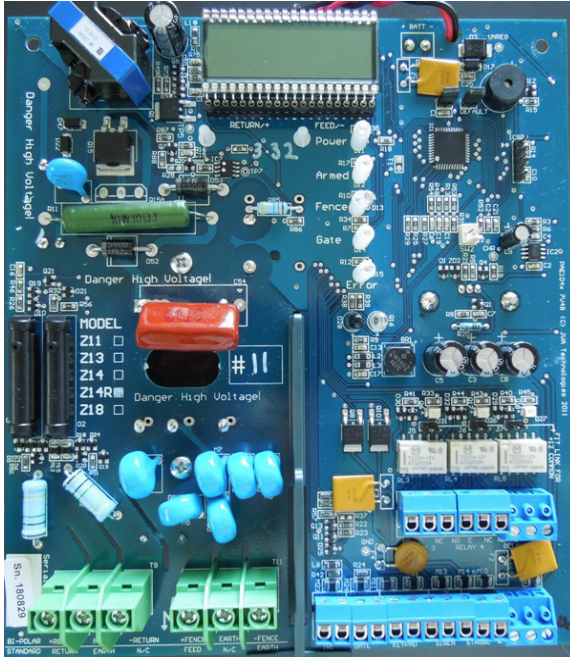

Installation

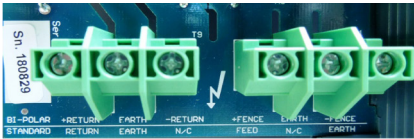

High Voltage Terminal



Low Voltage Terminal

5.3 Examples of Fence (High Voltage) Wiring Diagrams

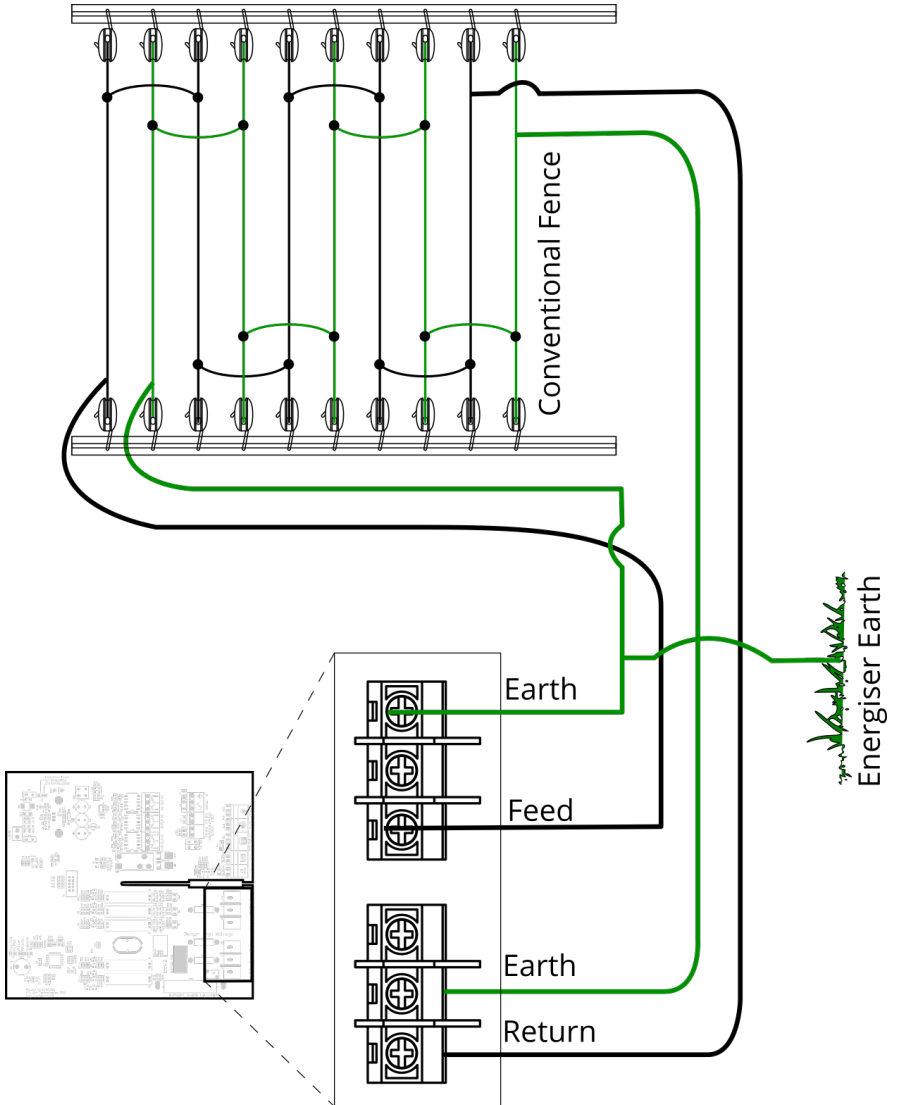

Z14 energizer configured for conventional fence operation

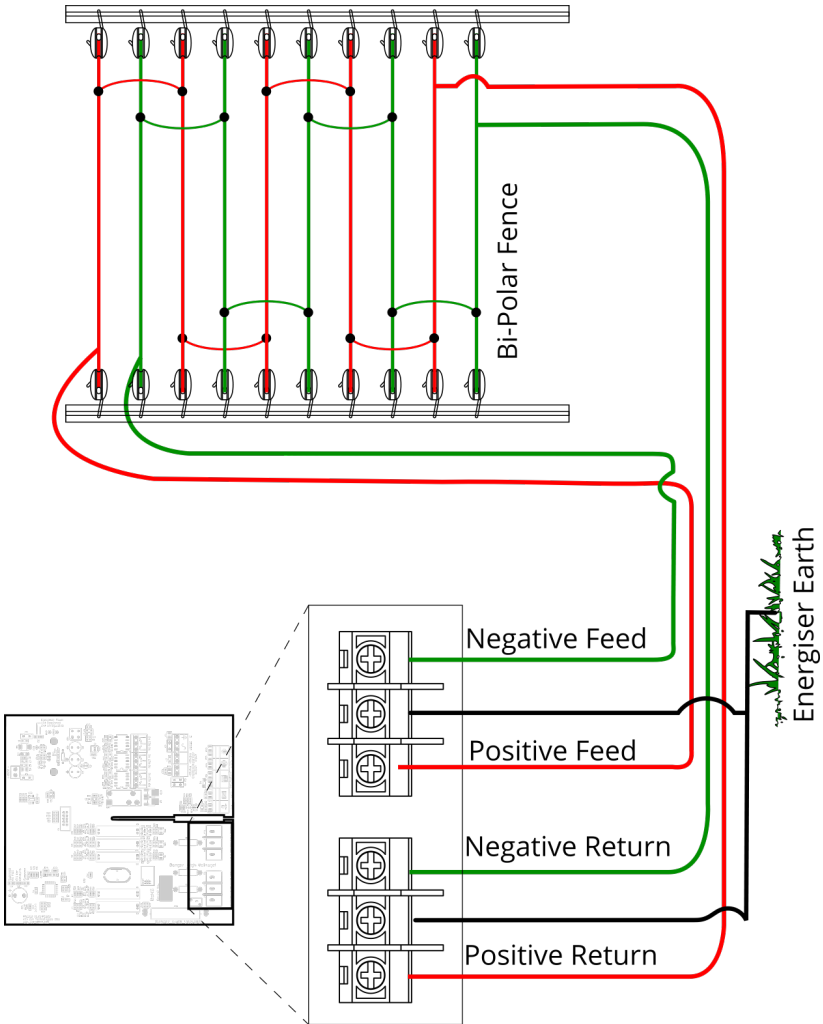

Z14 energizer configured for Bi-polar operation

6 CONTROL

Your JVA Z14 security energizer has been designed for ease of operation. It may be armed and disarmed using any of the following:

- Key switch or remote switch connected to the control input (IN1)
- Remote control radio receiver connected to IN1
- Z-Series Keypad (LCD or Touch)
- JVA GSM module
- Windows PC running JVA Perimeter Patrol
- Low level interface (wired to control inputs and relay outputs) from a third party security alarm panel or Physical Security Information System (PSIM)

NOTE: More than one method may be used in the one installation.

6.1 ARMING THE FENCE USING THE KEYPAD.

Enter your **User PIN #** (Default User PIN is 1234).

Make sure the red ARM light comes on.

- The keypad will beep twice to confirm that the system is armed.
- The fence will power up and if all is well (no faults) the system will be ready to deter and detect.
- If there is a fault on the fence and it cannot achieve full voltage, the LCD screen will indicate that there is a fault.
- To disarm the system, enter your User PIN and press #.

6.2 ACTIVATING LOW POWER MODE

To switch to Low Power mode, enter your **User PIN *41#**. In Low Power mode the fence will still be powered and any breach will be detected, but the voltage will be much lower than normal operation. The ARM light will flash in Low Power mode.

Enter your User PIN and press ***42#** to switch back to Full Power mode.

Alternatively, the unit can be switched to Low Power mode using a switch connected to a control input, if it has been programmed accordingly. See “8.5.20 Input Function and Trigger” on page 53

NOTE: Switching Power Mode will not automatically Arm the Energizer

6.3 WHEN AN ALARM OCCURS

If the system is armed and the fence is tampered with, the fence light will flash and then remain on. A siren or strobe connected to the unit will turn on. If the energizer is connected to an alarm system for monitoring, an alarm signal will be sent to the alarm company monitoring the alarm system.

NOTE: This output is available as a default setting on relay 3 on a Z14R.

An alarm will also sound if the gate input is opened and the entry/exit delay time has elapsed.

6.4 TO SILENCE THE ALARM

Enter **1470#** on the Keypad. This will silence the Siren but not disarm the system; the armed light will remain on and the Strobe will still indicate the Zone that was in Alarm.

Entering this command will force the Siren into its “Siren Off Time”. If the fault remains on the Fence, then the Siren will sound again after the “Siren Off Time” has elapsed. If however, the fault is cleared, then the Siren will be ready to sound again for the next Alarm.

Alternatively, disarming the energizer will silence the alarm.

6.5 CHANGING THE USER PIN

- Enter the current **User PIN** (default is 1234) and press ***0#**. This enters User Programming mode.
- Enter your new **User PIN** (must be 4 digits) and then **#**.
- Press ***#** to exit User Programming mode.
- Make sure your new User PIN works by using it to arm the energizer.

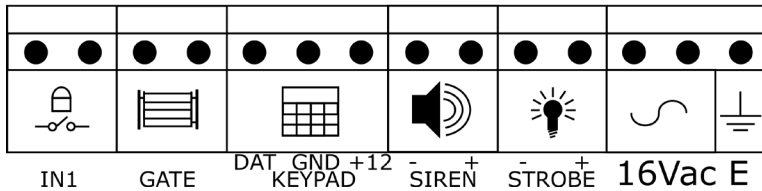
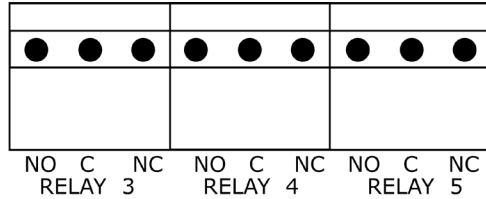

Label	Type	Description
IN1	2 Way	Energizer control input 1 (dry contact momentary) internally wired in parallel with the key switch. Can be used for a remote switch or a radio receiver. The receiver may be powered from the keypad +12V terminal.
GATE	2 Way	Energizer control input 2 (dry contact). Default function is gate input, normally closed. When the unit is armed and the gate is opened, it will trigger the gate alarm. Alternatively, this input can be programmed to make the energizer alternate between Low Power and High Power mode.
KEYPAD	3 Way	Supplies power and data line for an external keypad. The +12 source on these terminals is protected with 1A self resetting fuse.
SIREN	2 Way	Switched 12V output. 30W max, shared between Siren and Strobe. A buffer relay should be used when connecting these outputs to an alarm panel. Low side switched

Label	Type	Description
STROBE	2 Way	Switched 12V output. 30W max, shared between Siren and Strobe. A buffer relay should be used when connecting these outputs to an alarm panel. Low side switched
16Vac	3 Way	16Vac 1.5A power input plus earth. Connection of the earth is only required where local safety or wiring codes demand it. This should be connected to the cabinet or mains earth NOT the fence earth.
Batt	Battery leads	12V dc or battery connection via F1 (4 Amp slow blow fuse).
Relays 3, 4 and 5	3 Ways	Relays 3, 4 and 5 are fitted on the Z14R models, and allow for programmable alarms to be set to each relay, for a list of available alarms see section 8.5.16.

7.1 POWER OPTIONS

The Z14 has 2 sources of power, 16VAC and 12VDC (battery). If using solar power and an external battery, connect the battery to the battery leads, not the 16Vac input.

A 24Vdc 1.5A supply can be used in place of the 16Vac supply. The correct connection is +24V to the left AC pin, GND to the middle AC pin. Due to the stored energy in a 24Vdc plug-pack, an AC fail may take up to 5 minutes to be reported.

NOTE: Use only rechargeable batteries.

7.2 STANDBY BATTERY

Should there be a loss of mains power, the power light on the keypad will go off. If the loss of power is prolonged, the battery may discharge power and become ineffective. The power light will start to flash indicating a battery low power problem. If the battery is fully depleted, the unit will not pulse.

If the standby battery requires replacement, the power light will flash and the status light will flash three times.

7.3 STATUS CODES

Status LED Number of Flashes	Interpretation	Corrective Action
1	Tamper detected	Fit the energizer lid or link J3 (Z14R only)
2	Mains supply fail	Restore mains power
3	Low battery, bad battery	Charge or replace battery
4	PCB service fault	Seek advice from your installer or distributor

If a minor error occurs, it will self-clear if the error condition is removed. If the mains fail or the battery runs low, it will not disarm the energizer. However, without mains power, the battery will eventually be depleted and the energizer will attempt to maintain operation by entering Low Power mode after 4 warning beeps. If the battery charge continues to fall, the energizer will eventually stop. Once mains power has been restored and the battery has recovered, the energizer will rearm itself automatically after 4 warning beeps. A PCB fault will disarm the energizer. If an error disarms the energizer, the fence alarm will be activated.

If an error has momentarily caused the energizer to stop pulsing, this can be corrected by disarming and rearming the unit. Should the error recur return the unit for service.

7.4 ERROR CODES

LCD Error Message	Meaning
“Fatal” errors	These will stop the unit
Er-11	Memory CRC error (not shown yet)
Er-12	Capacitor unplugged or “bad”
Er-13	Capacitor cannot charge
Er-14	SCR is fast firing
Er-15	Capacitor failed to discharge

LCD Error Message	Meaning
Er-16	Energiser cannot see the Master Energiser via Keypad Bus
Er-18	The Keypad circuitry is faulty

7.5 JUMPERS

Jumper	Function	Purpose
J3 (Z14)	Inhibit Mains fail error	J3 is fitted to inhibit Mains fail errors if the intention is to operate the energizer on DC only (as in solar power systems).
J3 (Z14R)	Tamper disable	Disables the Infrared Tamper feature. This Jumper will need to be fitted if you wish to test the unit with the cover off.
J4	Factory default jumper Off to return programmable options to factory defaults on power up.	If the energizer needs to be defaulted to factory settings, remove all power (AC and battery) and remove the J4 jumper. Reapply the mains and the battery power. Reapply the J4 jumper and the Energizer will be reset to default settings.
J5, J6 & J7 (Z14R only)	Supply +12V to Relay Common. J5: Relay 3 J6: Relay 4 J7: Relay 5	Fitting a jumper will supply +12V to the specific relay common. NOTE: This is a low current system, it cannot supply more than 20mA per relay.

How to fit a Jumper/Bridge/Shunt

A fitted Jumper is shown as closed in the diagram below. If a jumper is not to be fitted it can be placed over a single pin, this is shown as open in the diagram below.

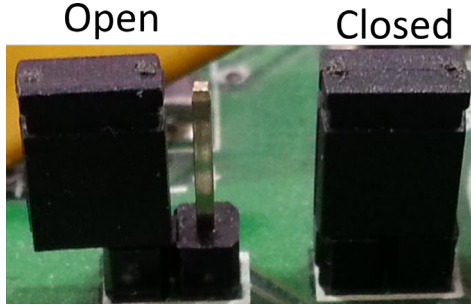

7.6 CONFIGURING BI-POLAR MODE

By default the Z14 is configured to run in standard mode. This procedure explains how to modify the Z14 so that it will run in Bi-Polar mode.

Step 1

On the back of the Z14 PCB near the high voltage output terminals there is a link (pictured below) which needs to be cut. Cut and remove the link so that it is flush with the PCB at both points where it is soldered to prevent any arcing.

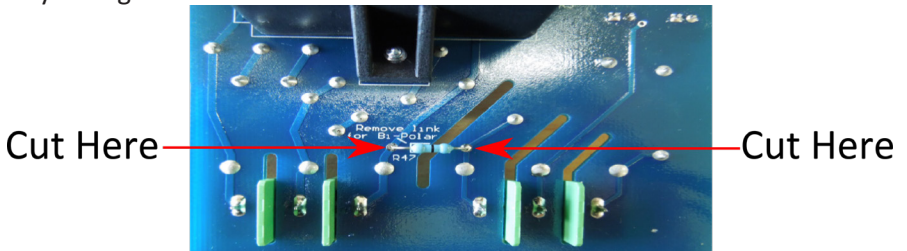

Step 2

Set Fence Mode (Option 15) to bipolar.

Value	Function
0	Bi-Polar
1	Conventional
2	Z14R Bi-Polar
3	Z14R Conventional

NOTE: Returning the energizer to defaults has no affect on this setting.

7.7 TAMPER CIRCUIT (Z14R ONLY)

The tamper circuit serves two functions. It protects service personnel from receiving a shock by disarming the energizer when the lid is removed. It also sounds alarm if the lid is removed while the energizer is running. The tamper alarm can be inhibited by shorting the J3 pins together. It should be noted that in order for this function to work the inside of the energizer lid needs to have a small piece of reflective material above the IR tamper circuit.

8 PROGRAMMING OPTIONS

The Z14 has permanent memory in which the programming options are stored. These are factory pre-set but can be field programmed using a Z-Series keypad. To see the programming options in brief see “1.1 Changing The Programming Options” on page 6

8.1 PROGRAMMING MODE

To enter Programming mode, enter the 6-digit Installer PIN (default is 012345) followed by *, 0, # keys. The keypad will beep twice to indicate that the command was accepted. If the Installer PIN was incorrect, the keypad will beep 3 times. Pressing the # key will cycle through all the options on the LCD.

NOTE: Not all option numbers are used.

8.2 TO EXIT PROGRAMMING MODE

After programming, press *, # to exit. If left unattended, the unit will time out and auto exit Programming mode after approximately 5 minutes.

8.3 CHANGING THE INSTALLER PIN

The installer PIN may only be changed while in Programming mode.

To enter a new installer pin, press **00** followed by the new 6-digit Installer PIN, then the # key.

If you cannot remember your Installer or User PIN, return the unit’s memory to default. To do this, remove power (AC off and disconnect the battery), open the energizer, remove jumper J4 and reconnect the battery for about 10 seconds. Re-fit J4.

This will return all options to the factory set defaults.

8.4 CHANGING AN OPTION

Most of the options have possible values in the range of 0 to 9.

To change any options, the unit must be in Programming mode. Check the option number (see table below) and then the table of values for that option. Then press the option number followed by the required value. When the programming is completed, exit from Programming mode. (See above)

For example, to change the power level to maximum, enter programming mode and press 0199#, and the keypad will beep twice to indicate that the

command was successful.

8.5 PROGRAMMING OPTIONS IN DETAIL

NOTE: The bold panel in each table indicates the default value.

8.5.1 Output Power Level (Option 1)

The power level option allows the shocking power of the fence to be adjusted. The value entered is the Voltage level in 100's of volts.

The Default setting is 85 (8.5kV), the Maximum is 99.

For example: To change the power level to 6.8kV, enter 0168#.

The keypad will beep twice to indicate that the new option has been accepted. The actual fence voltage depends on the amount of fence wire and fence conditions.

This option may affect the average power drain and therefore backup battery time.

Energizer Function	Key1	Key2	Key3	Key4	Key5
High Power Level	0	1	100's volts		#

8.5.2 Low Power Mode Output Voltage (Option 2)

Same as above, but for Low Power mode.

The Default setting is 11 (1.1kV), the Maximum is 20.

Energizer Function	Key1	Key2	Key3	Key4	Key5
Low Power Level	0	2	100's volts		#

8.5.3 Fence Return Alarm Voltage (Option 3)

This option sets the voltage threshold below which the fence alarm will occur. The value entered is the Voltage level in 100's of volts.

The Default setting is 40 (4.0kV) in conventional mode, the Maximum is 60.

The Default setting is 30 (3.0kV) in Bi-Polar mode.

In Bi-Polar mode this threshold is for both positive and negative fence wires.

Energizer Function	Key1	Key2	Key3	Key4	Key5
Fence Return Alarm Voltage	0	3	100's volts		#

8.5.4 Fence Return Alarm Voltage for Low Power Mode (Option 5)

This option sets the voltage threshold below which the fence alarm will occur.

The Default setting is 05 (0.5kV), the Maximum is 15 (1.5kV).

Energizer Function	Key1	Key2	Key3	Key4	Key5
Fence Return Alarm Voltage for Low Power mode	0	5	100's volts		#

8.5.5 Missed Pulse Count (Option 6)

This option sets the number of bad or missing pulses that are counted before the alarm occurs.

The Default setting is 03, the Maximum is 99.

NOTE: The lower this option is set, the more likely you are to get false alarms.

Energizer Function	Key1	Key2	Key3	Key4	Key5
Missed Pulse Count	0	6	New Value		#

8.5.6 Battery Alarm Voltage (Option 7)

This option sets the battery voltage threshold below which the alarm will activate. The default Battery Alarm Voltage is 10.0 Volts and the unit will drop to low power at 9.0 Volts (after beeping 4 times).

If the unit enters Low Power mode due to a flat battery, the unit will automatically return to high voltage, without warning, when the mains voltage comes back on and the battery voltage rises.

Key3	Alarm	Reduce Power
0	9.0V	8.0V
1	9.5V	8.5V
2	10.0V	9.0V
3	10.5V	9.5V
4	11.0V	10.0V
5	11.5V	10.5V
6	12.0V	11.0V
7	12.5V	11.5V
8	13.0V	12.0V
9	13.5V	12.5V

8.5.7 Siren On Time (Option 8)

This option sets the duration of time that the siren will remain on after a fence alarm occurs. After this time the siren will turn off for the Siren Off Time. The siren will sound again if the alarm is still present after this Siren Off Time has passed.

The default is 2 minutes. This may be the subject of local regulations to stop an alarm causing undue disturbance to neighbours, etc.

NOTE: The Siren On Time will be cut short if the battery falls below the low battery level.

Key3	Time
0	10 Seconds
1	30 Seconds

Key3	Time
2	1 Minute
3	2 Minutes
4	3 Minutes
5	4 Minutes
6	5 Minutes
7	20 Minutes
8	45 Minutes
9	130 Minutes

8.5.8 Siren Off time (Option 9)

This option sets the amount of time the siren will be off for after the “Siren On Time” above has expired. If an alarm is still present after this off time, the siren will sound again.

Key3	Time
0	10 Seconds
1	1 Minute
2	2 Minute
3	5 Minutes
4	10 Minutes
5	20 Minutes
6	30 Minutes
7	40 Minutes
8	50 Minutes
9	60 Minutes

8.5.9 Siren Cycles (Option 10)

This option sets the maximum number of times the siren will sound for the “on time” if the alarm continues. This may be limited by local regulations to stop an alarm causing undue disturbance to neighbours, etc.

NOTE: This is the maximum number of cycles for 1 continuous alarm.

Key3	Cycles
0	1
1	1
2	2
3	3
4	4
5	5
6	6
7	7
8	8
9	9

8.5.10 Gate Entry/Exit Delay (Option 13)

The gate switch must remain open for longer than the Gate Entry/Exit Delay before the gate alarm is triggered.

Key3	Time
0	0 Seconds (immediate)
1	30 Seconds
2	1 Minute
3	2 Minutes
4	3 Minutes
5	4 Minutes
6	5 Minutes
7	6 Minutes
8	7 Minutes
9	8 Minutes
10	15 minutes
11	30 minutes
12	45 minutes
13	60 minutes

8.5.11 Chime Mode (Option 14)

This option allows the energizer internal and keypad beeper to be used as a door chime for the gate switch. When set to None, the keypad beeper is used to indicate correct keypad operation only. When set to Door Chime mode, both beepers will sound when the gate switch opens, even if the energizer is disarmed.

NOTE: “Gate Function” must be selected for an input. If set to siren, both beepers mimic the siren function.

Gate Beeps plus Siren will give 2 beeps on gate open and 4 on close, plus continuous for an alarm. This option is different as beeps are on the keypad only, not the internal beeper.

Key3	Function
0	None
1	Door Chime
2	Siren
3	Fence Alarm
4	Gate beeps plus Siren

8.5.12 Fence Mode

This option sets the fence mode from conventional mode to Bi-Polar mode. Conventional mode is where you have alternating live and ground wires. Conventional mode however ensures that every fence wire is live.

Key3	Function
0	Bi-Polar
1	Conventional
2	Z14R Bi-Polar
3	Z14R Conventional

8.5.13 Combined Options (Option 16)

Each option in this table can be turned on by adding the corresponding value. E.g., if you require maximum power at all times and you would like to enable the IR tamper circuit you would require option +2 and option +8

from the list below.

This equates to setting option 16 to 10 because $2 + 8 = 10$.

+2: Maximum power at all times. NOTE: Turning this option on may remove IEC standards compliance.

+4: Limits a Z14 to 2.5J per zone in group mode.

+8: Enables the IR tamper detection under the lid. J3 changes function to inhibit tamper.

+16: Stop energizers on E-16 (Coms Fail) if the communications from the group master is lost.

+32: Stops the energizer sending alarm memory to a PC, relay PCB or keypad. Set this to restore “unlatched” mode on a PAE201 relay PCB.

+64: Allow the energizer to operate at full power without a battery. The AC supply must be sufficient to power all hardware connected.

Key3 and 4	Function
0	None
+2	Max Power
+4	2.5 Joules Limit
+8	IR Tamper enabled
+16	Stop energizer on coms fail
+32	Do not send Alarm memory
+64	No Battery

8.5.14 Anti-Bridging threshold (Option 17)

Anti-bridging has been designed to detect a section of fence being bypassed, and removed from circuit, by an intruder bridging the feed to returns together and then cutting the live wires in between.

Setting this option to a value greater than 0 (default is 0 = off) will enable Anti-bridging, however this feature will not operate in low power mode. While Armed, a fence alarm will trigger if the fence voltage rises OR falls quickly by more than the threshold. A slow change to the voltage will not trigger a fence alarm until the voltage is less than the Fence Alarm Voltage (Option 03).

The Anti-bridging Threshold is a percentage value of the current fence voltage. For Example, setting option 17 to 10 (1710#) will set a 10% Anti-bridging Threshold. At this level a fence (return) voltage normally reading 7.5kV will trigger a fence alarm if the voltage quickly rises to over 8.3kV or falls to less than 6.7kV.

NOTE: Power Level (option 1) must be set higher than the normal fence running voltage, otherwise if the load is released (fence bridged) voltage control will limit the voltage rise and the anti-bridging alarm will not activate. For the above example, option 1 must be set to 7 or greater to allow the un-loaded fence to rise to 8.3kV or higher, thus triggering the Alarm.

8.5.15 Combined Options 2 (Option 18)

Each option in this table can be turned on by adding the corresponding value.

For option +1 set 18 to 01, for +1 and +2 set option 18 to 03.

+1: Enables Siren Acknowledge. The siren will chirp once for armed and twice for disarmed.

+2: Enables a home alarm style entry/exit delay for the gate input.

+4: Sets the keypad bus baud rate to 4800 (default is 2400), all units in a group, PC and keypad must be set to the same baud rate. The change will not take effect until after a reset.

+8: Sets the keypad bus baud rate to 9600 (default is 2400)

+16: Enable Low Power Bite mode. If the Energizer (running in Low Power Mode) detects a "Fence Touch", it will immediately start pulsing in High Power for 5 pulses before reverting back to Low Power Mode.

+32: Enables Bite to Low Power mode. If the Energizer (running in High Power Mode) detects a "Fence Touch", it will immediately start pulsing in Low Power Mode for 5 pulses before reverting to High Power Mode.

A "Fence Touch" is detected when the fence voltage drops below the threshold for one pulse

NOTE: Only enable one Bite modes at a time.

Key3	Function
0	None
+1	Siren codes
+2	Gate delay type
+4	4800 baud
+8	9600 baud
+16	Low Power Bite
+32	Bite to Low Power

8.5.16 Auto Re-arm Time (Option 20)

This option sets the time which must elapse before another alarm will sound after the first alarm has timed out (gone completely through its cycles without being turned off). If an event occurs (such as a low fence voltage) which triggers the siren, any other events which would otherwise trigger the siren (such as a gate alarm) will be ignored while the siren is sounding and until after the Auto Re-arm time has passed. A setting of 0 will disable Auto Re-arm.

If this time is set to less than the Siren Off Time, the Energizer may re-arm in the "Off" time and the number of Siren Cycles will be reduced.

Key3	Time
0	0 Seconds (Immediate)
1	30 Seconds
2	1 Minute
3	2 Minutes
4	3 Minutes
5	4 Minutes
6	5 Minutes
7	6 Minutes
8	7 Minutes
9	Disabled – Do not auto rearm

Programming Options

8.5.17 Relay Programming

All relays can be set to any of the available functions (user assignable).

Command	Key1	Key2	Keys 3 and 4	Key 5
Relay 1	2	1	Options Explained under “8.5.18 Relay Functions” Default is 08	#
Relay 2	2	2	Options Explained under “8.5.18 Relay Functions” Default is 09	#
Relay 3 (Z14R only)	2	3	Options Explained under “8.5.18 Relay Functions” Default is 00	#
Relay 4 (Z14R only)	2	4	Options Explained under “8.5.18 Relay Functions” Default is 02	#
Relay 5 (Z14R only)	2	5	Options Explained under “8.5.18 Relay Functions” Default is 07	#

8.5.18 Relay Functions

The table below is for use for the relay programming options mentioned in the above table.

Key3 4	Function	Description
00	Fence	Triggers when Zone 1 is Armed and Return Voltage is below the Threshold Voltage In Bipolar - Triggers when the positive output is below the Threshold Voltage
01	Fence or Off	Triggers when Zone 1 is off or return voltage is below the threshold voltage
02	Armed	Zone 1 is armed
03	Fence 2	Bipolar only - Triggers when the negative output is below the Threshold Voltage
06	Fence Bi-Polar	Triggers when energizer is armed and the fence return voltage on either Bi-Polar return line has fallen below the threshold voltage
07	General	Triggers on AC Fail, Tamper, Low Battery/Bad Battery, Gate Alarm or Internal error. Latched (internal errors only)
08	Siren	Triggers on Fence alarm , Gate or tamper. Will time out after the Siren Time Out time. Latched
09	Strobe	Triggers on Fence alarm, Gate or Tamper. Only turns off on Energizer disarm. Latched
10	AC Fail	Triggers on AC Fail
11	Low/Bad Battery	Triggers on low or bad battery
12	Tamper	Triggers when the case has been opened and J3 has been fitted (Z14R only)
14	Gate	Triggers on Gate
15	Gate Siren	behaves like siren, only for Gate alarms
16	Armed Low Power	Triggers when armed in Low Power mode

Key3 4	Function	Description
17	Group Armed	Triggers when group is armed. Only configurable on group master.
18	Group general	Triggers on group general alarm. Only configurable on group master.
20	Host Control	This Relay is completely controlled from a Host system such as Perimeter Patrol or a Keypad. If the Host system is disconnected from the Energizer for more than 30 seconds, the Relay will automatically change to the Alarm State
21	Host Control - Not Fail Safe	This Relay Host Controlled however if the Host system is disconnected then the Relay will maintain its current state

NOTE: The siren and strobe switched 12V outputs can be used to drive external buffer relays.

8.5.19 Group Mode (Option 26)

A group of Energizers must have only one master. Each energizer in the group must have a different value programmed into Option 26. Since the keypad bus is common among the group, one keypad can be used to program all units for all options except this Group Mode.

The procedure is:

1. Connect the keypad directly each Energizer in turn
2. Program the Group Mode value for that Energizer
3. Link all Z-Series devices (via the Keypad Bus) into a group

Key3 and 4	00	01	02	...	15
Group Mode	No Group	Group Master	ID 2	etc	ID 15

8.5.20 Input Function and Trigger

Each Input is configured independently using two digits to configure the Trigger followed by the Function.

Input 1 is Option 27. **Default setting is 20** - Momentary Toggle Input with Arm/Disarm Function

Input is Option 28. **Default setting is 06** - Normally Closed Input with a Gate Function

Key3	Input Trigger	Key4	Input Function
0	Normally Open (Active when Closed)	0	Arm when Active / Disarm otherwise
1	Normally Closed (Active when Open)	1	Arm when Active / Disarm otherwise
2	Momentary Toggle (Toggle between states)	3	Low Power when Active / High Power otherwise. Requires Energizer to be Armed
3	NO Pulse Extend (Extend a short Close signal by 3 seconds)	4	Low Power when Active / High Power otherwise. Requires Energizer to be Armed
4	NC Pulse Extend (Extend a short Open signal by 3 seconds)	6	Gate is Open when Active / Closed otherwise
		8	Tamper Alarm triggered when Active
		9	Pass Through input signal to other device

9 SPECIFICATIONS

9.1 Z14R SPECIFICATION

Specification Name	Specification
Energizer Output Voltage	9.5kV peak no load
Peak Output Energy	4 Joules at 500 Ohms, limited to 2.5J in Group Mode
Pulse Rate	Locked at 0.8 Hz
12v Dc Power Consumption	Energizer on – 550mA average, 700mA peak Energizer off – 28mA (40mA with keypad) Not including keypad or auxiliary power
Ac Power Input	16-18Vac or 24Vdc
Battery Charger Output	Float voltage 14V, 600mA, short circuit and reverse polarity protection utilising 4A slow SMD fuses.
Siren and Strobe Outputs	Self-resetting fuse protection, switched 12V, rated at 30W (combined)
Switched outputs	Three 30V 1A “Form C” change-over contacts
Enclosure	IP4x ABS plastic
Size	300mm high, 190mm wide, 115mm deep
Weight – packed, no battery	1.9kg

9.2 Z14 SPECIFICATION

Specification Name	Specification
Energizer Output Voltage	9.5kV peak no load
Peak Output Energy	5 Joules at 500 Ohms
Pulse Rate	Locked at 0.8 Hz
12v Dc Power Consumption	Energizer on – 550mA average, 876mA peak Energizer off – 16mA (28mA with keypad) Not including keypad or auxiliary power
Ac Power Input	16-18Vac or 24Vdc
Battery Charger Output	Float voltage 14V, 500mA, short circuit and reverse polarity protection utilising 4A slow SMD fuses.
Siren and Strobe Outputs	Self-resetting fuse protection, switched 12V, rated at 30W (combined)
Enclosure	IP4x ABS plastic
Size	300mm high, 190mm wide, 115mm deep
Weight – packed, no battery	1.9kg



- There are no user-serviceable parts in this unit.
- The installer is reminded that high voltages are retained for a while after switching off, and to wait for at least 10 minutes before opening the case.
- Before working on the high voltage wiring of an electric fence, it is recommended that the energizer be turned off and an intentional short circuit be placed from the fence live wires to earth.
- Electric fences are not toys; do not let children play with them.

This appliance is not intended for use by persons (including children) with reduced physical, sensory or mental capabilities, or lack of experience and knowledge, unless they have been given supervision or instruction concerning use of the appliance by a person responsible for their safety. Children should be supervised to ensure that they do not play with the appliance.

10 Z-SERIES KEYPADS

There are 2 different keypads that can connect to the keypad bus of a Z-Series device:

- PTE0240 4-line keypad
- PTE0230 Touch Keypad

A keypad can be used to control, program and monitor the devices on your fence.

10.1 PTE0240 4-LINE KEYPAD



JVA's mid-range keypad features include:

- Quick Arm/Disarm keys
- 4-line Backlit LCD Display
- Menu driven interface
- Menu driven device programming
- 500 entry event log with date and time stamps



JVA's most advanced keypad features include:

- Touch screen with clean user interface designed for ease of use
- Quickly arm or disarm the entire site or granularly via the Zones screen
- Emails on alarm
- View all active and latched alarms in the alarms screen
- Program all Z-Series devices through an intuitive system, without having to remember or refer to a manual for key sequences. With the new MK2 protocol, these devices can be all programmed together without having to isolate each device individually
- Quiet mode: set a time where the Keypad won't brighten the screen or set off loud sirens unless it is critical such that you might enjoy a restful night's sleep.
- The ability to monitor and log all user actions
- Large detailed event log

10.3 CONNECTING MULTIPLE KEYPADS

Function	Code	Default Code
Re-analyse the Keypad group	[User Pin]*68#	1234*68#

Up to three keypads may be used to remotely monitor and control Z-Series devices.

To operate correctly, each keypad must be configured to use a unique keypad address. This is best achieved by connecting one keypad (at a time) to the master Z-Series device and updating the keypad address. Once all keypads have a different address, all can be connected to the system. Enter the above command using the keypad (at address 1).

10.4 KEYPAD CONFIGURATION NOTES

Zone 1 (the master) must be connected to the group. If it is not connected to the other Z-Series devices in the group, the keypad will report a communications failure with all the zones.

After connecting an LCD keypad to a group of devices, enter *68# on the keypad to 'discover' the connected energizers. Ensure that all Z-Series devices are disarmed first.

NOTE:

1. If the group ID has recently been changed you may need to reset, [User Pin] * 6 8 # before the new ID's will be properly reported to the keypad.

10.5 CALIBRATING THE VOLTAGE DISPLAY

The PCB's will be factory calibrated and should not require adjustment for the life of the product. If, however, certain components are replaced during repair the Energizer may need recalibration. This includes the main processor chip.

Procedure:

1. On the energizer Fence connectors, connect Return to Feed terminals and Earth (Return) to Earth (Feed) terminals.
2. Plug in the keypad, power the unit and turn on the energizer using the key-switch.

Clearing old calibration using the keypad:

3. Type [Installer's Code] *, 0, # Enter programming mode
4. Type 9, 8, 0, 0, # Clear the calibration for the Left value
5. Type 9, 9, 0, 0, # Clear the calibration for the Right value
6. Type *, # Exit programming mode

Once the calibration is cleared, run the energizer and record the actual voltages produced by the energizer using a fence meter. Record the values displayed on the LCD. The actual voltages must be higher than the values displayed on the LCD for calibration to work.

Left value
(Return for Z14 standard)
(Return2 for Z14 Bi-Polar)

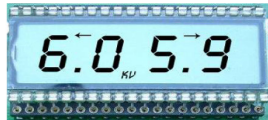

Right value
(Feed for Z14/R standard)
(Return2 for Z14/R Bi-Polar)

7. Calculate the return calibration factor

$$(\text{Actual Voltage} * 100 / \text{Displayed voltage}) - 100$$

For example If after clearing the calibration the Actual fence voltage is 7.1 but the display left value reads 6.0 (as per the picture above) the factor is:

$$(7.1 * 100) / 6.0 = 118.3$$

$$118.3 - 100 = 18.3 \text{ (Ignore the value after the decimal point)}$$

For the Left value, the factor to enter is 18 (an increase of 18 percent).
Using the same process for the Right value (above picture shows 5.9kV),
For the right value, the factor to enter would be 20.

Entering new calibrations using the keypad (for our example)

8. Type [Installer's Code] *, 0, #Enter programming mode
9. Type 9, 8, 1, 8, # Enter the Left calibration
10. Type 9, 9, 2, 0, # Enter the Right calibration
11. Type *, #. Exit programming mode

Z-Series Keypads

10.6 SUMMARY OF KEYPAD FUNCTIONS

Default Installer PIN	012345									
Default User PIN	1234									

Command	Key1	Key2	Key3	Key4	Key5	Key6	Key7	Key8	Key9	Key10
Arm/Disarm	USER PIN									
Silence the Energizer Siren	1	4	7	0	#					
Enter Programming Mode	INSTALLER PIN									
Enter Keypad Programming Mode	INSTALLER PIN									
Exit Programming (Any Mode)	*	#								
Change a User PIN, 4 Digits	USER PIN									
Arm All Zones (Multi-Zone Groups)					*	0	#	[New PIN]	#	
Arm Specific Zone (up to Zone 15)	USER PIN									
Disarm All Zones	USER PIN									
Disarm Specific Zone (up to Zone 15)	USER PIN									
Switch to Low Power Mode (All Zones)	USER PIN									
Switch Specific Zone to Low Power	USER PIN									
					*	4	1	#		
					*	4	1	Zone No.	#	

Command	Key1	Key2	Key3	Key4	Key5	Key6	Key7	Key8	Key9	Key10
Switch to High Power Mode (All Zones)		USER PIN			*	4	2	#		
Switch Specific Zone to High Power		USER PIN			*	4	2	Zone No.		#
Arm Gate Zone only		USER PIN			*	4	#			
Bypass Siren (All Zones)		USER PIN			*	5	2	#		
Bypass Specific Zone Siren		USER PIN			*	5	2	Zone No.		#
Re-enable Siren		USER PIN			*	5	1	#		
Re-enable Specific Zone Siren		USER PIN			*	5	1	Zone No.		#
Bypass Gate Alarm (All Zones)		USER PIN			*	5	4	#		
Bypass Specific Gate Alarm		USER PIN			*	5	4	Zone No.		#
Re-enable Gate Alarm (All Zones)		USER PIN			*	5	3	#		
Re-enable Specific Gate Alarm		USER PIN			*	5	3	Zone No.		#
Arm in Agricultural Mode (No Alarms)		USER PIN			*	9	Zone No.			
Reset and Display Firmware Version		USER PIN			*	6	8	#		
Reset and Return to Factory Defaults		INSTALLER PIN			*	*	6	8		#

Energizer Function	Key1	Key2	Key3	Key4
Clear Alarm Memory	*	1	#	
Display the Group ID of the Energizer	*	2	6	#
Siren Test	*	6	3	#
Battery Test	*	6	4	#

Keypad Specific Function	Key1	Key2	Key3	Key4
Re-Analyse the Energizer Group	*	6	8	#
Keypress Beep On/Off	*	5	1	#
Chimes On/Off	*	5	3	#
Error Tones On/Off	*	5	4	#
Keypad Alarm Tones On/Off	*	5	5	#
Change Backlight Mode	*	8	#	
Display Keypad Model	*	9	#	

11 REMOTE CONTROL UNIT

The Remote Control Unit provides the Z14 with the ability to arm or disarm the energizer via a compact key chain fob remote control.

11.1 FEATURES

- Enables arm / disarm of the energizer, or a single zone, by key chain fob remote control
- 2 remote controls included
- Uses digital rolling-code algorithm to uniquely and securely couple to remote controls
- Operates between 315 – 433.92MHz
- 100 metres range
- Easily connected and configured
- Wire to keypad bus (for power) and input (usually IN1)

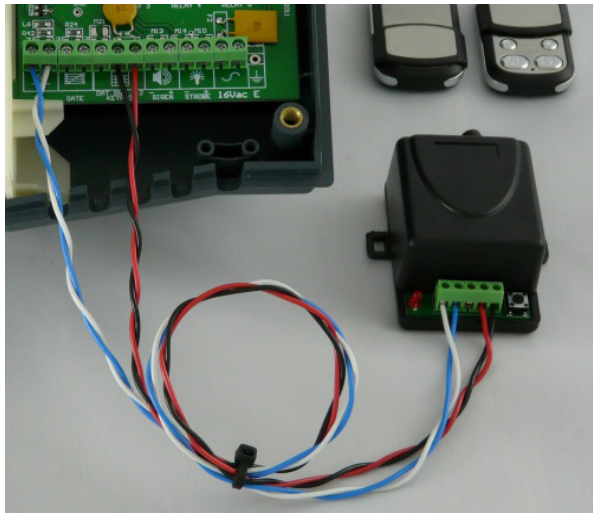

Remote Control Unit Receiver

11.2 INSTALLATION

The Remote control receiver unit requires 12V and 0V (GND) from the keypad bus, and its output wired to IN1.

Mount the receiver on the right hand side of the Z14 energizer. Connect +12V and 0V (GND) from the KEYPAD terminals on the energizer to the right-most terminals of the receiver, as per the diagram above.

Connect the IN1 terminals to the left-most terminals of the receiver.

Keep all connections away from any high voltage wiring, specifically the Fence Feed connections coming from the left side of the energizer.

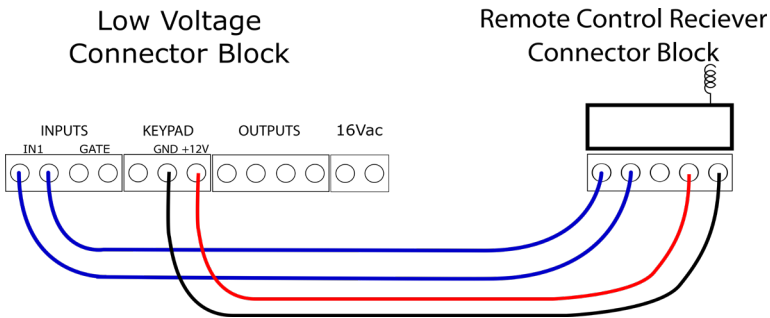

Remote Control Receiver Wiring Diagram

11.3 OPERATION AND CONFIGURATION

Simply press the LOCK key to arm the energizer. Press the UNLOCK key to disarm.

Should a remote control become lost or stolen, it is possible to disassociate the receiver with all remote controls. To do this, press the button on the bottom right corner of the receiver unit and hold for approximately 10 seconds. When the red light goes off the receiver has wiped all associated remote controls from its memory.

To associate a remote control, press the same button on the receiver once. The light will come on momentarily. Next, press a button on the remote control. The receiver light will begin flashing. Press the same button on the receiver again and the light will stop flashing. Test the remote control by pressing a button.

12 STANDARD REQUIREMENTS FOR SECURITY ELECTRIC FENCES

12.1 DEFINITIONS

Connecting lead

An electric conductor, used to connect the **energizer** to the **electric fence** or the earth **electrode**

Electric animal fence

An **electric fence** used to contain animals within or exclude animals from a particular area

Electric fence

A barrier which includes one or more electric conductors, insulated from earth, to which electric pulses are applied by an **energizer**

Electric security fence

A fence used for security purposes which comprises an **electric fence** and a physical barrier electrically isolated from the **electric fence**

12.2 GENERAL REQUIREMENTS FOR ELECTRIC FENCES

1. **Electric fences** shall be installed and operated so that they cause no electrical hazard to persons, animals or their surroundings.
2. **Electric fence** constructions which are likely to lead to the entanglement of animals or persons shall be avoided.
3. INSTALLERS/USERS SHOULD NOTE: WARNING: Avoid contacting electric fence wires especially with the head, neck or torso. Do not climb over, through or under a multi-wire electric fence. Use a gate or a specially designed crossing point.
4. An electric fence shall not be supplied from two different energizers or from independent fence circuits of the same energizer. For any two different electric fences, each supplied from a different energizer independently timed, the distance between the wires of the two electric fences shall be at least 2.5 m. If this gap is to be closed, this shall be affected by means of electrically non-conductive material or an isolated metal barrier.

5. Barbed wire or razor wire shall not be electrified by an **energizer**.
6. Any part of an **electric fence** which is installed along a public road or pathway shall be identified at frequent intervals by warning plates securely fastened to the fence posts or firmly clamped to the fence wires.
 - The size of the warning plates shall be at least 100 mm x 200 mm.
 - The background colour of both sides of the warning plate shall be yellow. The colour on the plate shall be black and shall be either:
 - The symbol of figure 7, or
 - The substance of "Caution - ELECTRIC FENCE".
 - The inscription shall be indelible, inscribed on both sides of the warning plate and have a height of at least 25 mm.

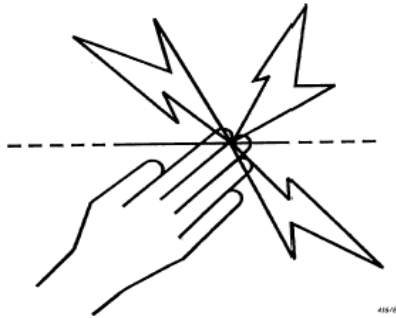

Warning plate symbol

7. The energizer earth **electrode** shall penetrate the ground to a depth of at least 1 m.
8. **Connecting leads** that are run inside buildings shall be effectively insulated from the earthed structural parts of the building. This may be achieved by using insulated high voltage cable.
9. **Connecting leads** that are run underground shall be run in a conduit of insulating material or else insulated high voltage cable shall be used. Care shall be taken to avoid damage to the connecting leads due to the effects of animal hooves or tractor wheels sinking into the ground.
10. **Connecting leads** shall not be installed in the same conduit as the mains supply wiring, communicating cables or data cables.
11. **Connecting leads** and electric fence wires shall not cross above overhead power or communication lines.

12. Crossings with overhead power lines shall be avoided wherever possible. If such a crossing cannot be avoided, it shall be made underneath the power line and as nearly as possible at right angles to it.
13. If **connecting leads** and **electric fence** wires are installed near an overhead power line, the clearances shall be not less than those shown in table.

Power line voltage V	Clearance m
<=1 000	3
>1 000 <=33 000	4
>33 000	8

Minimum Clearances from Power Lines

14. If **connecting leads** and **electric fence** wires are installed near an overhead power line, their height above the ground shall not exceed 2 m. This height applies either side of the orthogonal projection of the outermost conductors of the power line on the ground surface, for a distance of
 - 2 m for power lines operating at a nominal voltage not exceeding 1,000 V.
 - 15 m for power lines operating at a nominal voltage exceeding 1,000V.

12.3 PARTICULAR REQUIREMENTS FOR ELECTRIC ANIMAL FENCES IN AUSTRALIA

1. A distance of at least 10 m shall be maintained between the **energizer earth electrode** and any other earthing system such as the power supply system protective earth or the telecommunication system earth.
2. **Electric fences** intended for deterring birds, household pet containment or training animals such as cows need only be supplied from low output **energizers** to obtain satisfactory and safe performance.
3. In **electric fences** intended for deterring birds from roosting on buildings, no **electric fence** wire shall be connected to the **energizer earth electrode**. A warning plate, as described above, shall be fitted to every point where persons may gain ready access to the conductors.
4. A non-electrified fence incorporating barbed wire or razor wire may be used to support one or more off-set electrified wires of an **electric**

animal fence. The supporting devices for the electrified wires shall be constructed so as to ensure that these wires are positioned at a minimum distance of 150 mm from the vertical plane of the non-electrified wires. The barbed wire and razor wire shall be earthed at regular intervals.

5. Where an **electric animal fence** crosses a public pathway, a non-electrified gate shall be incorporated in the **electric fence** at the point or a crossing by means of stiles shall be provided. At any such crossing, the adjacent electrified wires shall carry warning plates as described above.

12.4 INSTALLATION OF ELECTRIC SECURITY FENCES

12.4.1 General

An electric security fence should be installed so that, under normal conditions of operation, persons are protected against inadvertent contact with pulsed conductors.

NOTE:

1. This requirement is primarily intended to establish that a desirable level of safety is present or is being maintained in the physical barrier.
2. When selecting the type of physical barrier, the likely presence of young children should be a factor in considering the size of openings.

12.4.2 Location of electric security fence

The electric fence should be separated from the public access area by means of a physical barrier.

Where an electric fence is installed in an elevated position, such as on the inner side of a window or skylight, the physical barrier may be less than 1.5 m high where it covers the whole of the electric fence. If the bottom of the window or skylight is within a distance of 1.5 m from the floor or access level then the physical barrier need only extend up to a height of 1.5 m above the floor or access level.

12.4.3 Prohibited zone for pulsed conductors

Pulsed conductors shall not be installed within the shaded zone shown in Figure 8.

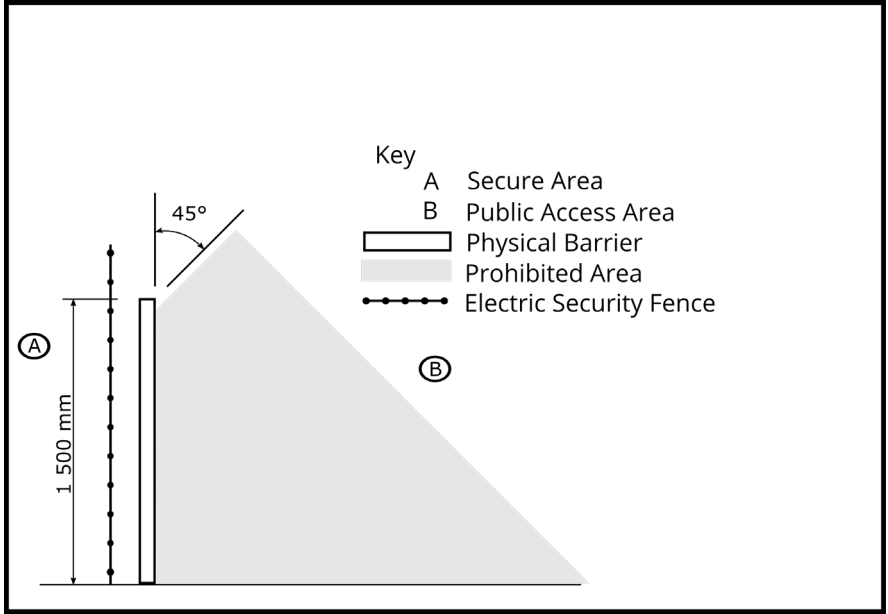

Prohibited Area for Pulse Conductors

NOTE: Where an electric security fence is planned to run close to a site boundary, the relevant government authority should be consulted before installation begins.

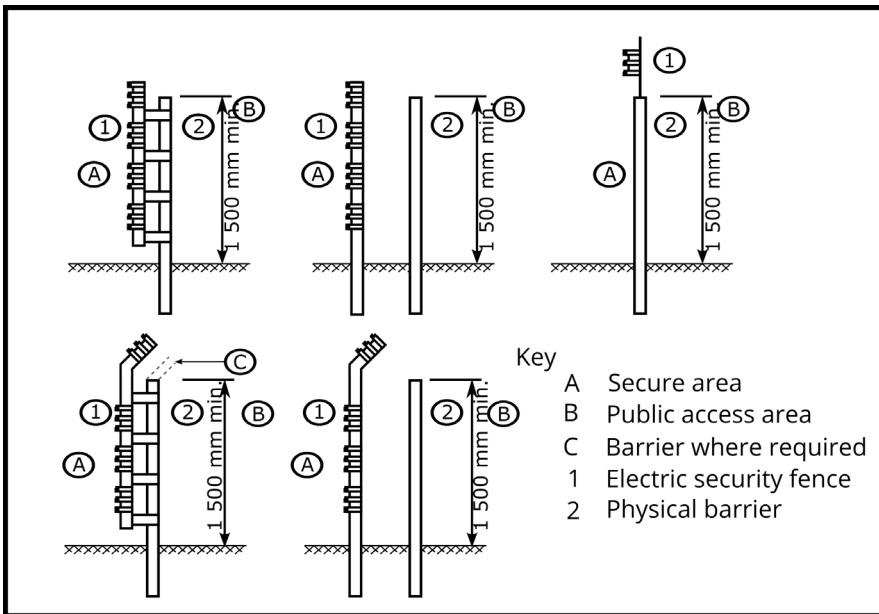

Typical Constructions where an Electric Security Fence is

Exposed to the Public

NOTE: Typical electric security fence installations are shown in Figure 9 and Figure 10.

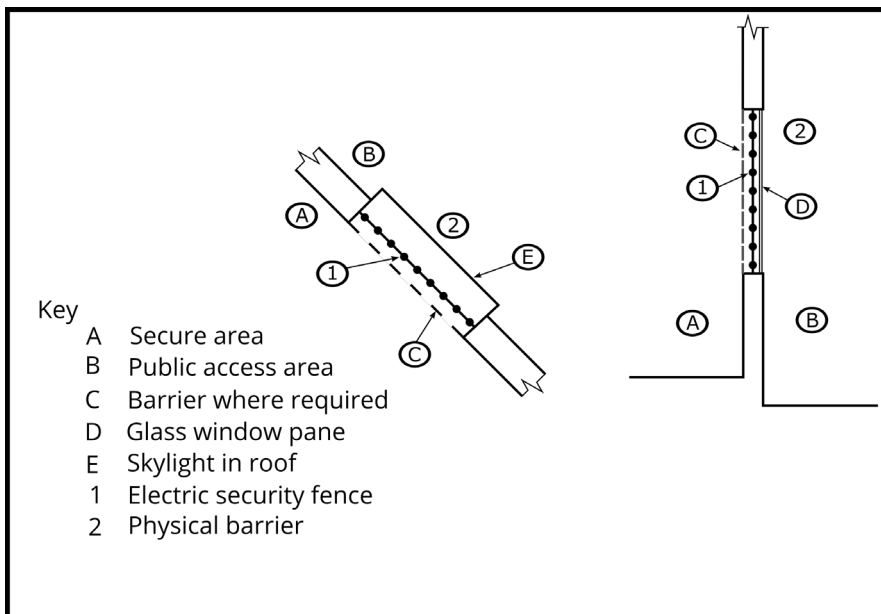

Typical fence constructions where the electric security fence is

installed in windows and skylights

12.4.4 Separation between electric fence and physical barrier

Where a physical barrier is installed in compliance with 3 at least one dimension in any opening should be not greater than 130 mm and the separation between the electric fence and the physical barrier should be

- within the range of 100 mm to 200 mm or greater than 1 000 mm where at least one dimension in each opening in the physical barrier is not greater than 130 mm;
- greater than 1 000 mm where any opening in the physical barrier has all dimensions greater than 50 mm;
- less than 200 mm or greater than 1 000 mm where the physical barrier does not have any openings.

NOTE:

1. These restrictions are intended to reduce the possibility of persons making inadvertent contact with the pulsed conductors and to prevent them from becoming wedged between the electric fence and the physical barrier, thereby being exposed to multiple shocks from the energizer.

2. The separation is the perpendicular distance between the electric fence and the physical barrier.

12.4.5 Prohibited mounting

Electric fence conductors should not be mounted on a support used for any overhead power line.

12.4.6 Operation of electric security fence

The conductors of an electric fence should not be energized unless all authorized persons, within or entering the secure area, have been informed of its location.

Where there is a risk of persons being injured by a secondary cause, appropriate additional safety precautions should be taken.

NOTE: An example of a secondary cause is where a person may be expected to fall from a surface if contact is made with pulsed conductors.

13 APPENDIX A: GROUP SIMULTANEOUS PULSE FEATURE

13.1 GROUP SIMULTANEOUS PULSE FEATURE

In some Industrial Installations it may be preferable to provide the ability to link multiple Energizers into a “Group”. Members of a group have simultaneous high voltage output pulses and act as if they are one energizer with multiple outputs. This is designed so that no possible combination of individual outputs can be dangerous.

13.2 GROUP MODE PROGRAMMING (OPTION 26)

Each Energizer in a group MUST have a unique Group ID value (from 1 to 15). A group MUST have a master device which has a Group ID value of 1.

For the Z14R Energizers, if there is no Master device, the other Energizers will display Error 4 on the Status LED when Armed and it will not electrify the fence. This is a requirement for Australian Standards.

For every other Z-series device, if there is no Master, each other Energizer will continue to electrify the fence (pulses) when Armed. However, the simultaneous pulse feature will NOT be operating.

NOTE:

1. Do not interconnect the energizers via the keypad bus until after they are programmed.
2. If more than one keypad is used, they will need different addresses.
3. If Perimeter Patrol is used any keypad in the system should not have address 2.

For all Energizers that will be part of a group, the procedure is as follows:

1. Make sure the key switch is turned off and IN1 isn't shorted.
2. Connect the battery.
3. On the keypad, enter [Installer's code] *, 0, #.
4. Enter 2, 6 followed by the required value (e.g. 1 for master) then #.
5. Enter *, # to exit programming.
6. Connect the group using the keypad bus as the Group Mode Linking diagram.

NOTE: At this time groups are limited to a master and 14 Group ID's (15 zones total)

Key3	Mode
0	No Group
1	Master
2	Group ID 2
3	Group ID 3
4	Group ID 3
5	Group ID 4
6	Group ID 5
7	Group ID 6
8	Group ID 7
9	Group ID 8
10	Group ID 9
11	Group ID 10
12	Group ID 11
13	Group ID 12
14	Group ID 13
15	Group ID 14

13.3 GROUP LINKING VIA THE KEYPAD “BUS”

The keypad terminals on all Energizers in the group are linked. Since only one Energizer needs to power the keypad, 3 wires are linked from one Energizer (preferably the Master) to the keypad (optional) and 2 wires to every other Energizer in the group. Do not connect the + lines between Energizers as this could result in some strange behaviour and possibly damage.

NOTE the connections can be a star or daisy chain or any mixture. It is possible for a PC to be added to the group using a keypad to USB adaptor (PAE223).

We recommend following these steps in the right order:

1. Disarm all energizers in the group. If energizers are not disarmed Step10 may not work correctly.
2. Program the keypad address using one of the energizers.
3. Program each energizer with its required address (Master address=1, Group ID 1 address=2...).
4. Connect any control/monitoring unit 12V, GND and Data to the Group Master.
5. Connect all Data and GND to the Group Master.
6. Connect the battery and AC power of the Group Master but do not arm.
7. Connect the battery and AC power of each energizer. Note: Do not arm them until all the Energizers in the group are connected.
8. Wait 5 minutes for all the Energizers to synchronise with the Master.
9. If there are more than one Z-Series keypad or control unit, make sure they have a different ID, then reset the group using keypad code: [User PIN] *, 6, 8, # or Perimeter Patrol's "Reset All" this will allow both keypads to be recognised by all energizers in the group.
10. If using a PTE0210 keypad, enter the key sequence *, 6, 8, # to automatically re-scan the group and check what energizers are connected.
11. Arm the group using keypad 1, 2, 3, 4, *, 1, 0, #, or by using Perimeter Patrol. Make sure all Energizers are activated.

Note:

1. Members of a group can be individually switched on and off; even the master can be turned off via input or key switch.
2. An energizer will generate a General alarm if the keypad bus is broken between it and the group master.
3. After programming the Keypad may be disconnected, it is not required for group operation.
4. When connected to Perimeter Patrol, the arm/disarm function of a keypad is disabled. Control of these functions is through the Perimeter Patrol interface.
5. A Keypad that is connected to a Group ID Energizer that is disconnected

from the Group, must have a KEYPAD ADDRESS set to 1.



Appendix A: Group Simultaneous Pulse Feature

Electric Fencing Products



DEALER



WWW.JVA-FENCE.COM